

#TL100100

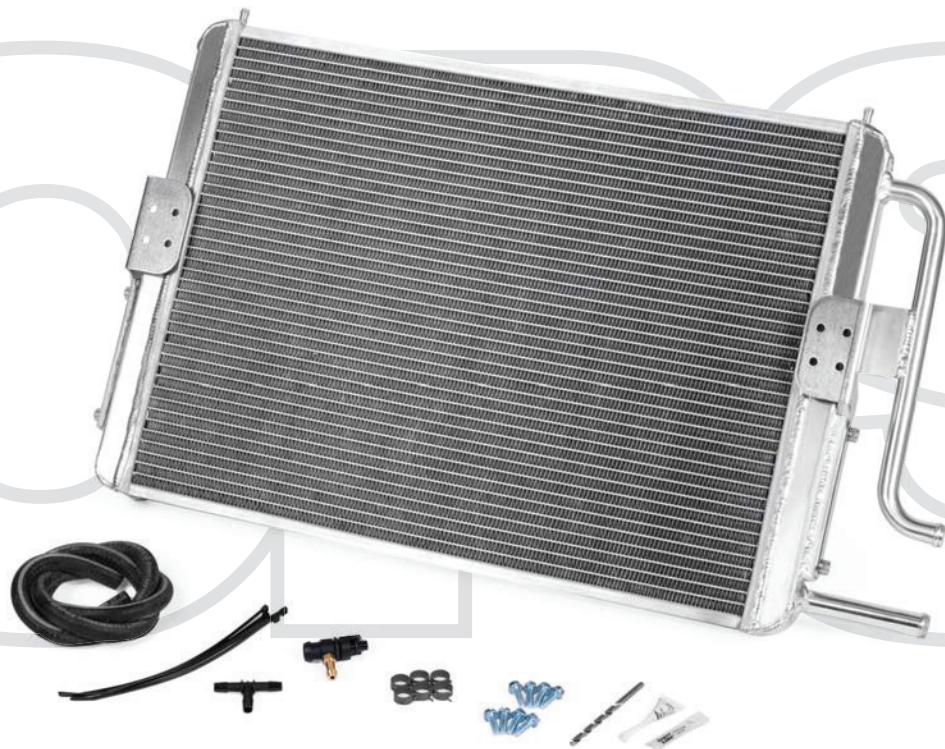

3.0T/4.0T COOLANT PERFORMANCE SYSTEM/  
INSTALLATION INSTRUCTIONS





---

Notes:

These instructions were written specifically for a North American specification B8 or B8.5 S4, but other models, like the Audi S5, A6 3.0T, A7 3.0T, Q5, and SQ5 are similar.

When disassembling the car, be sure to keep all fasteners so they can be reused. It is recommend that you get some kind of compartmented tray to organize the fastners, such as a fishing tackle box or several large ice cube trays. Fasteners that are not reused for reinstallation are noted in the instructions. All directions used in this manual (right, left, front, etc.) are based on if you were sitting in the drivers seat of the car.

These instructions assume that you have basic mechanical skills and several varieties of the tools of basic hand tools in order to install the kit. If you have any questions about the install, feel free to contact your APR representative.



WWW.GOAPR.COM

4800 US HWY 280 West Opelika Alabama 36801

**TL100100**

---

---

Slight variations in vehicle build dates or options may mean a difference in how your vehicle is configured, but the CPS kit contains enough parts for you to make a configuration for your vehicle. Typical Installations show the recommended installation on different cars. Alternate bleed hose configuration shows an alternate way to route the CPS coolant bleed without using the APR coolant tap, or if you have an issue with the factory plastic coolant hoses kinking. Finally, this manual shows in detail the installation of the APR CPS on a B8/B8.5 S4 or S5, so use it as a reference for other vehicles.

Index:

Typical Installation	Page Number
B8.5 S4/S5	1
B8 S4/S5	2
Early C7 A6/A7 3.0T	3
Late C7 A6/A7 3.0T	4
Q5/SQ5	5
S6/S7 4.0T	6
Alternate Bleed Hose Configuration	7-8
B8/B8.5 S4/S5 Installation	9-55

1) This is a typical installation on a B8.5 S4/S5 and is covered in detail in this manual. The coolant tap is used between the outlet of the stock engine radiator and the plastic tubing of the inlet hose. Both hoses to the factory supercharger radiator are reused on the APR CPS.

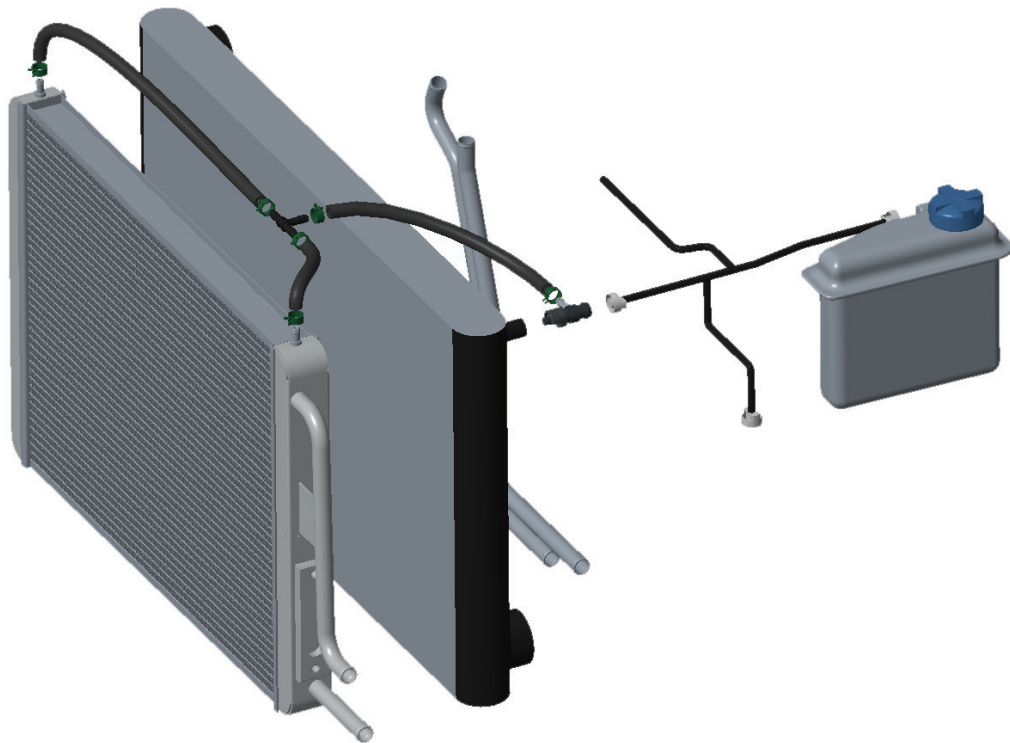

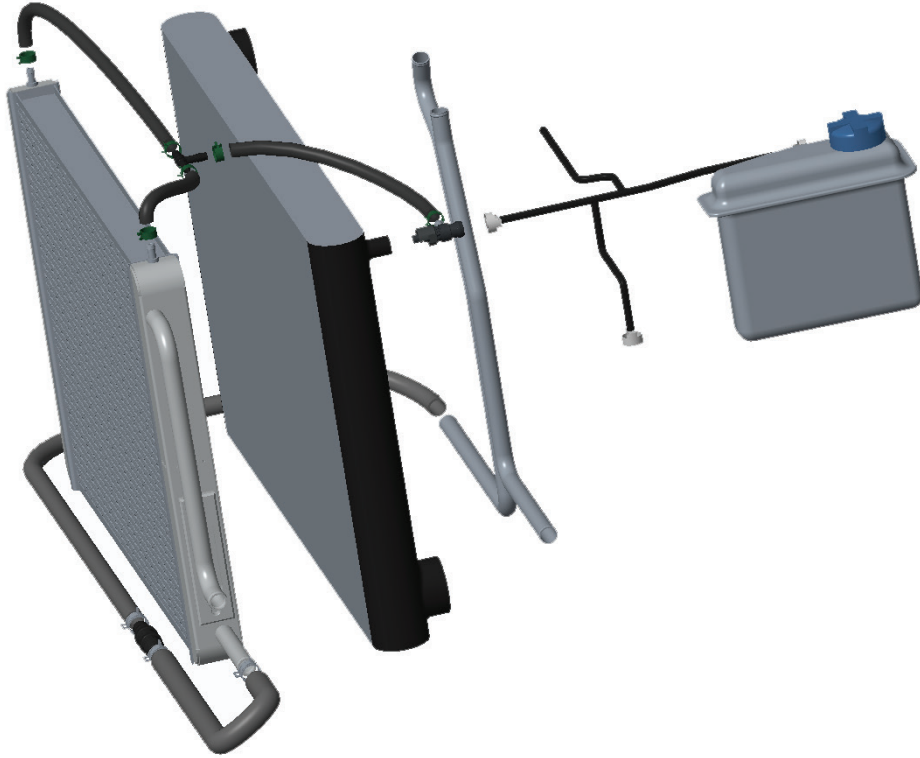

2) The recommended B8 S4/S5 is the similar to the B8.5 S4/S5. This install is covered in detail in this manual. The B8 cars have lower crossover plumbing will be needed as one of the coolant return pipes on the front of the engine is pointed towards the right side of the car. Attached the hose with the 180° bend to the lower outlet of the APR CPS radiator, and route the hose with the supplied line to the right side of the car.

3) Early C7 A6/A7 installation is like a B8 S4/S5, except the coolant tap is placed between the factory coolant expansion bottle and the factory plastic bleed tubing. The factory hose to the upper inlet of the APR CPS radiator will need to be extended with the supplied hose and coupler.

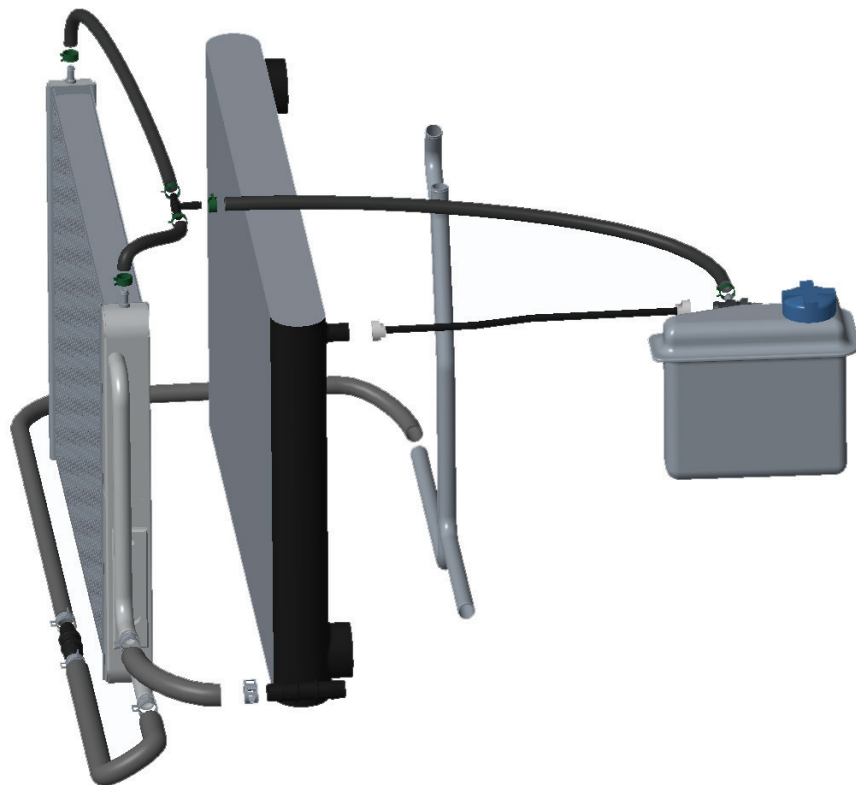

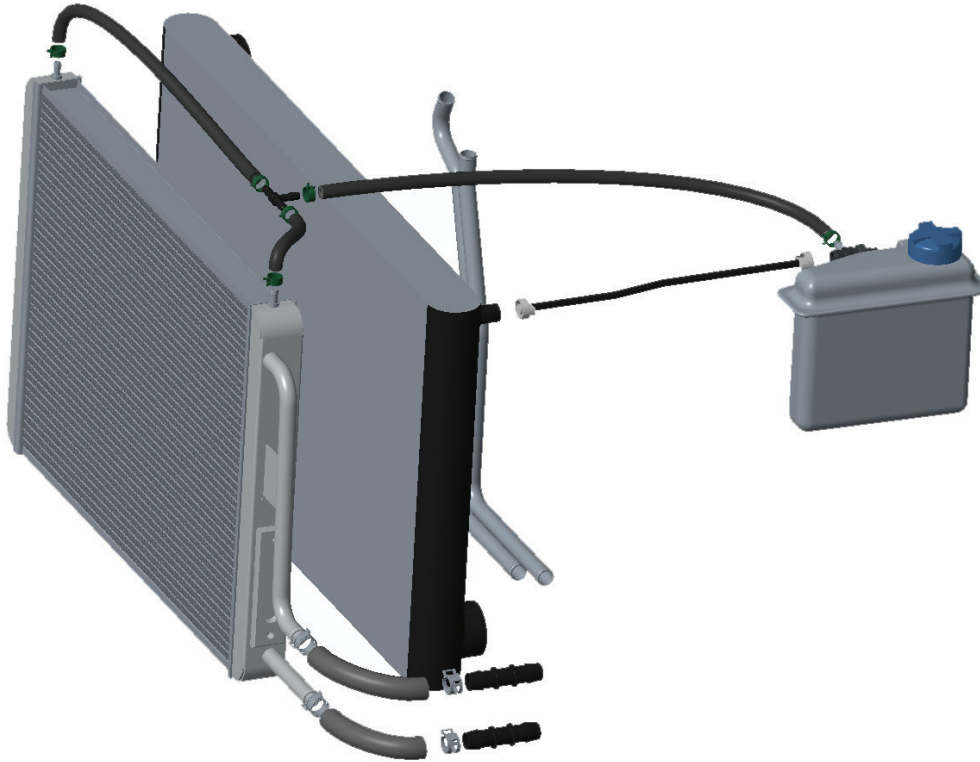

4) The later C7/C7.5 A6/A7 which have both engine coolant pipes facing the left side of the car can be configured as shown. The coolant tap is located between the factory coolant expansion bottle and the factory plastic bleed tubing. Both factory hoses to the APR CPS radiator will need to be extended with the supplied couplers, hose, and clamps.



5) The Q5/SQ5 setup is similar to the B8.5 S4/S5, except the lower factory coolant outlet hose will need to be extended with a supplied coupler, hose, and clamp. For the CPS bleed, there is a rubber line on the factory plastic bleeder hose assembly. Remove the rubber line and add a supplied tee, Use a short piece of the supplied bleeder hose to connect the tee back to the plastic bleeder hose and secure with the supplied clamps.

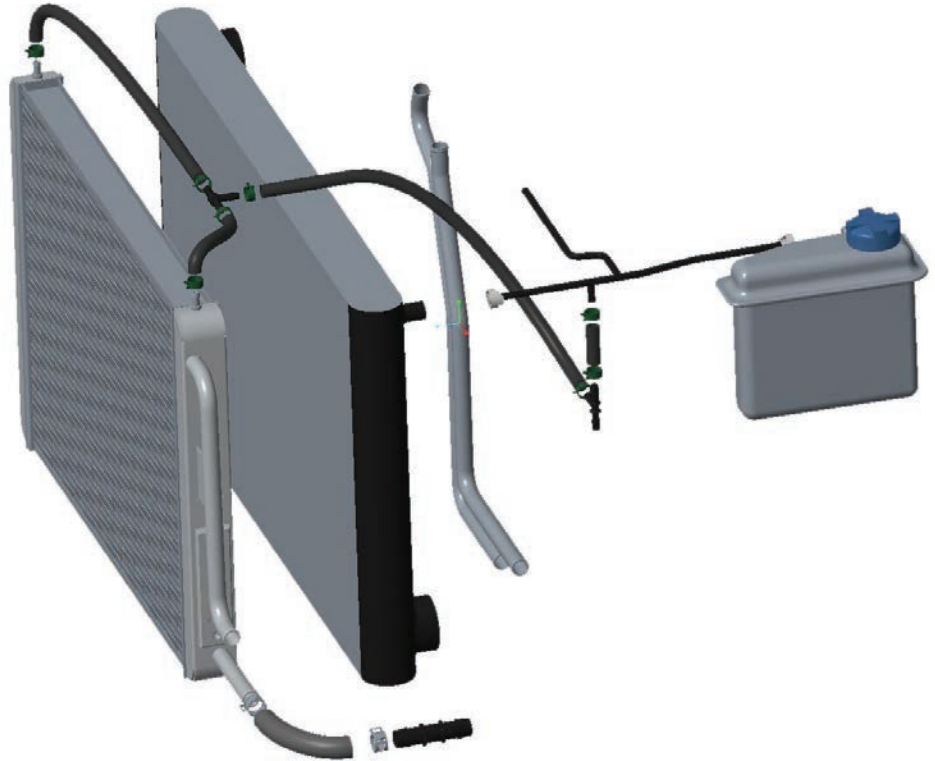

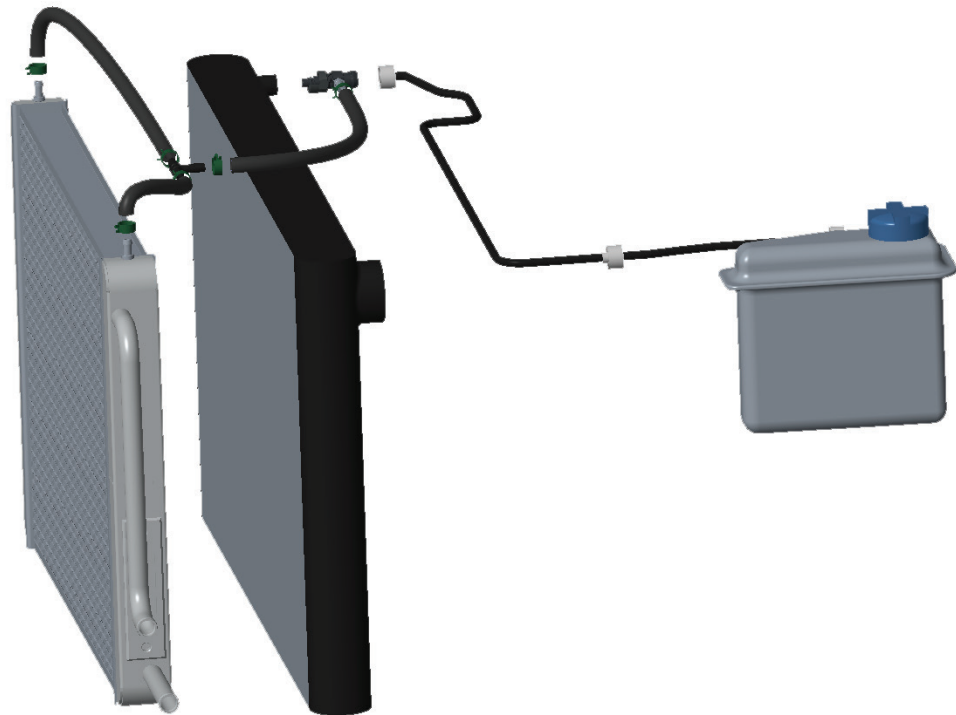

6) The S6 and S7 4.0T has the bleeder for the engine radiator on the right side, so the bleed lines from the APR CPS radiator are routed to the right side of the car, and an APR coolant tap is used at the engine radiator.

7) On some applications, the plastic factory coolant bleed lines can kink with the addition of the coolant tap. If necessary, the plastic lines can be cut and replaced with rubber hose, which is more flexible. Alternately, instead of using the APR coolant tap, the supplied tee fitting can be spliced in with rubber line to tie the APR CPS bleeders back into the factory cooling system.

To cut the plastic line, use a sharp razor blade and lightly score the plastic line several times at the barbed fitting. Once scored enough times, the plastic line is easily removed from the barbed fitting. If you press too hard while cutting, you can damage the barbed fitting underneath.

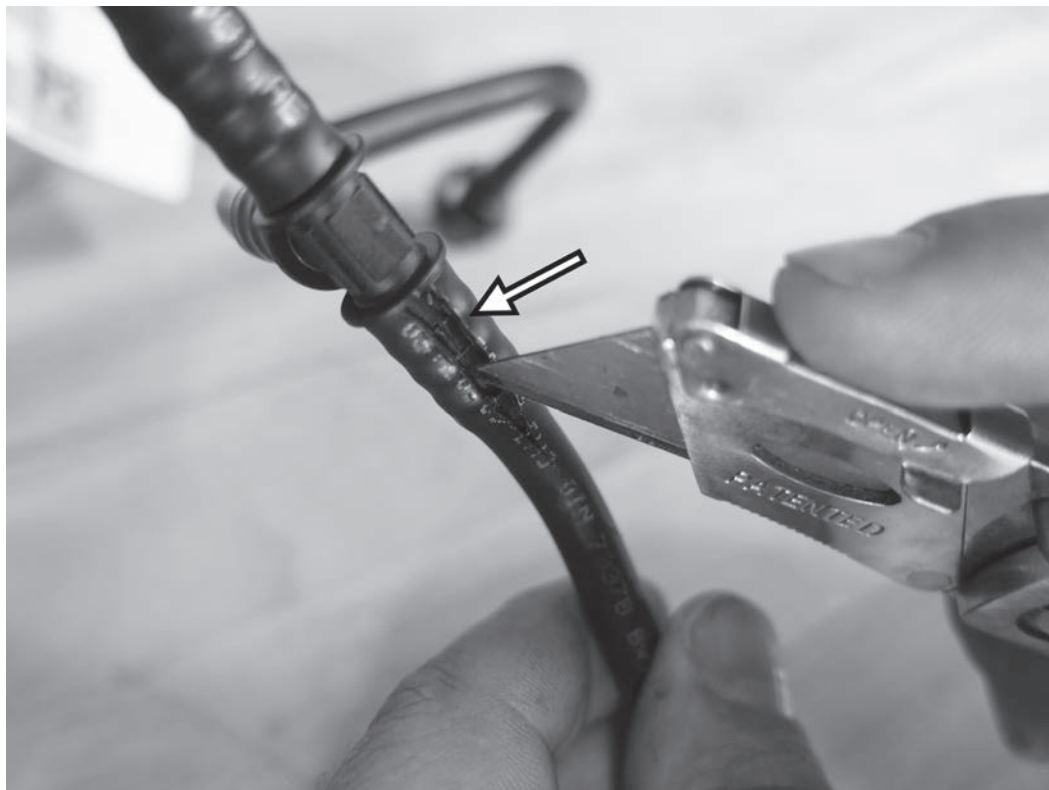



8) Install some of the supplied rubber line on the barbed fitting and secure with the supplied hose clamps. If using a tee fitting, simply install the tee in the rubber line and secure with the supplied hose clamps.

9) Securely lift vehicle. If a vehicle lift is not used, secure the vehicle with jack stands. Remove the left front wheel. If you are installing the full CPS kit, remove both front wheels.



**TL100100**

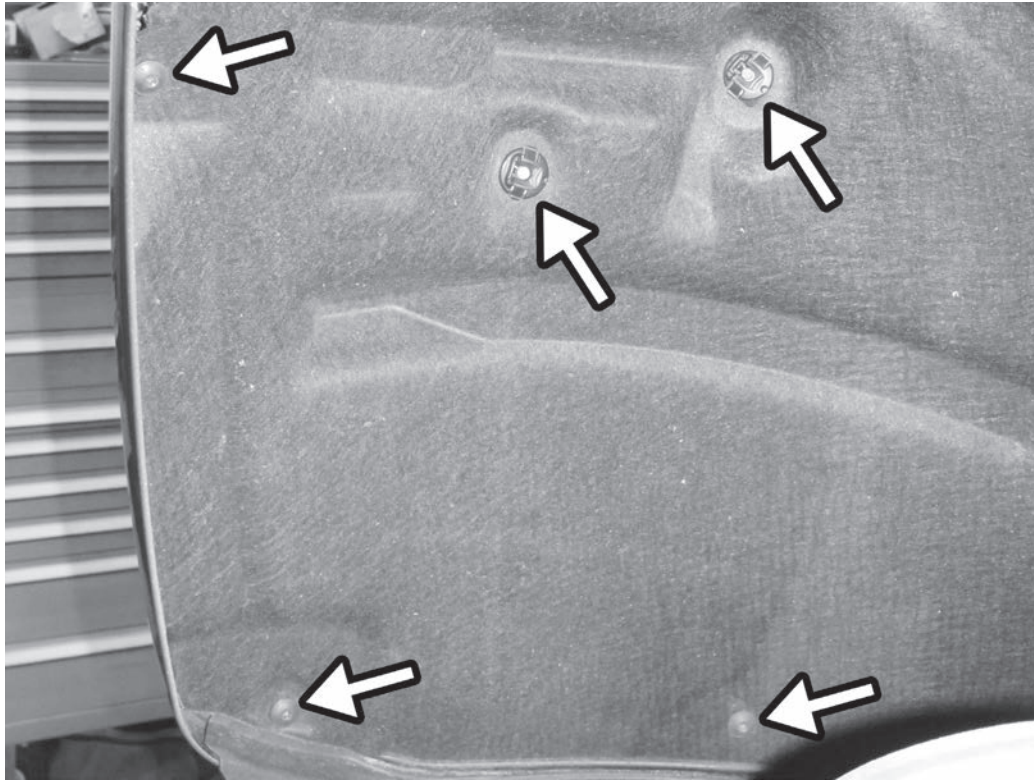

10) On both sides of the car, disconnect the three T25 Torx screws and two push tabs that hold the front half of left front fender liner to the car. Carefully bend the liner back behind the brake rotor so that it is out of the way. The B8.5 cars only have one push tab.

***APR***



11) Remove the 11 quarter turn fasteners from belly pan with a screwdriver and remove the belly pan.

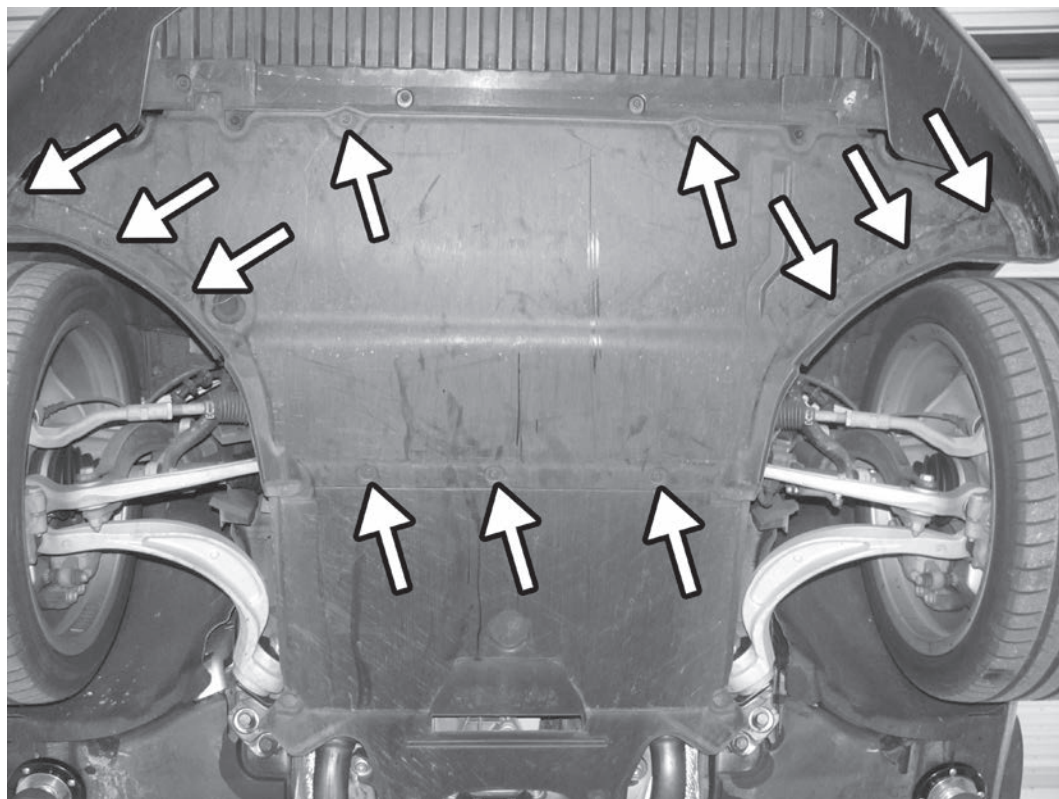

**TL100100**

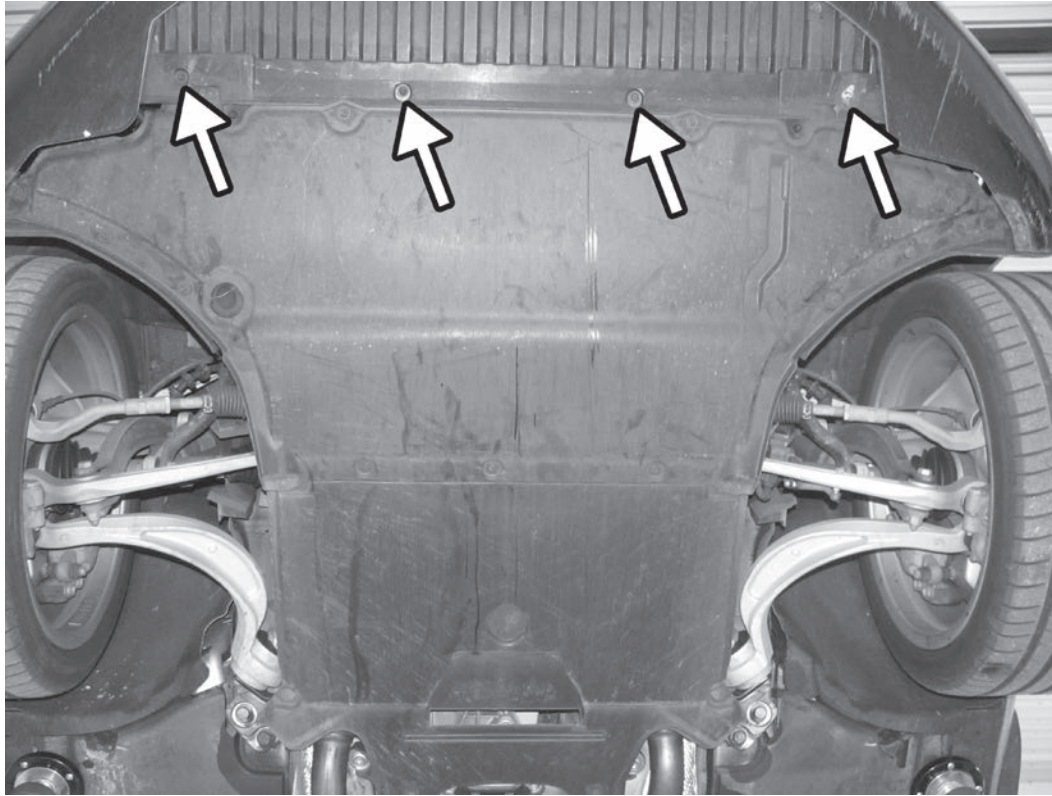

12) Remove the four T30 screws from the bottom of the front bumper cover.

**APR**



13) Pull back the front side of the fender liner on both sides of the car, and remove the 10mm bolt that holds the front bumper cover to the front fender.

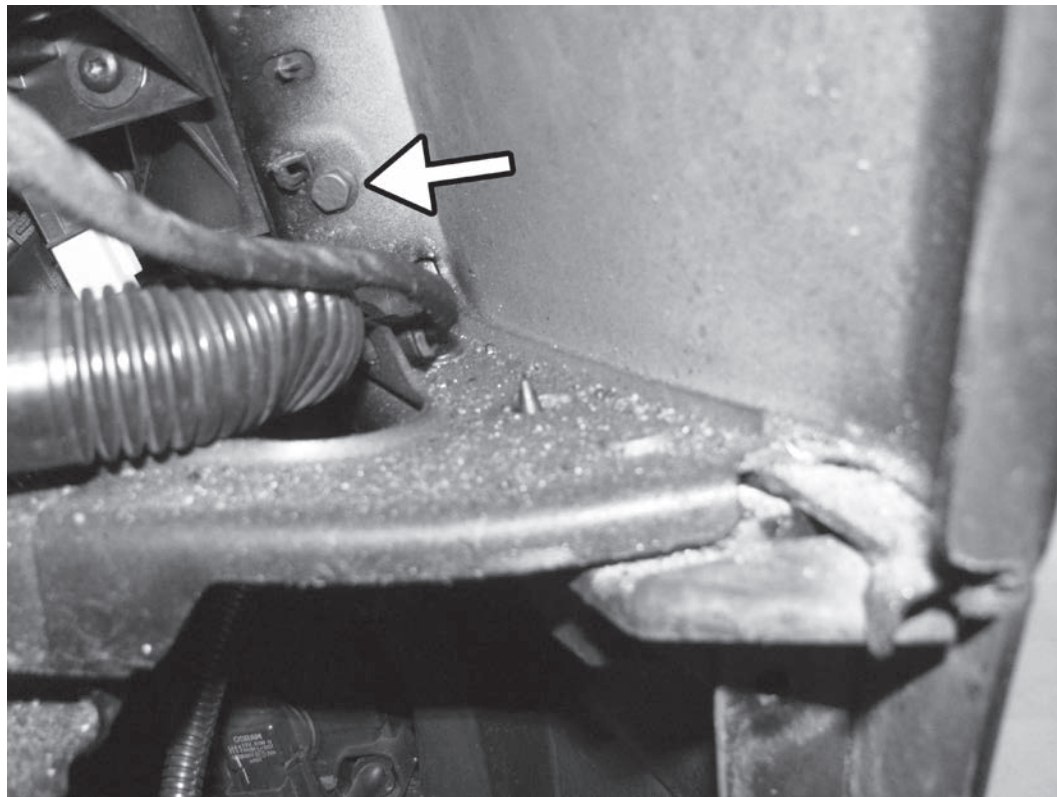

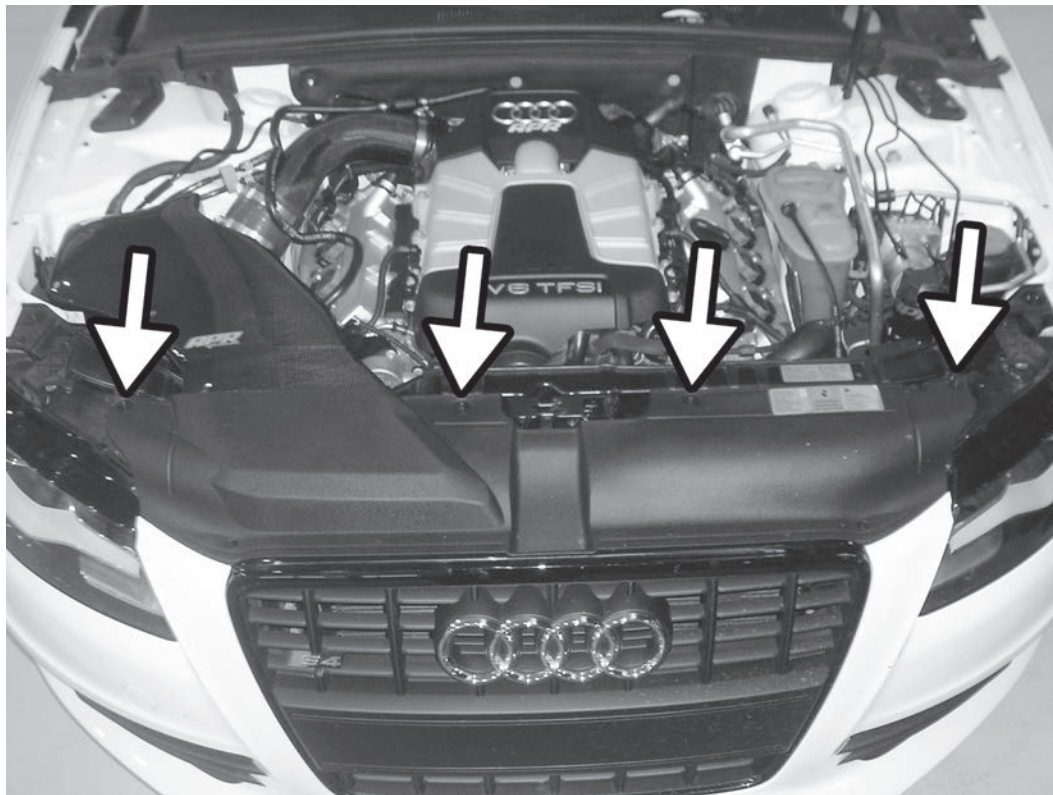

14) Remove the four T30 Torx screws from upper bumper trim cover and remove the cover.

The B8.5 cars use a push pin type fastener. Push the center of the fastener in, and then lift out the fastener from the outer ring.

15) Remove the two T25 screws from the top of the bumper cover near the headlights.

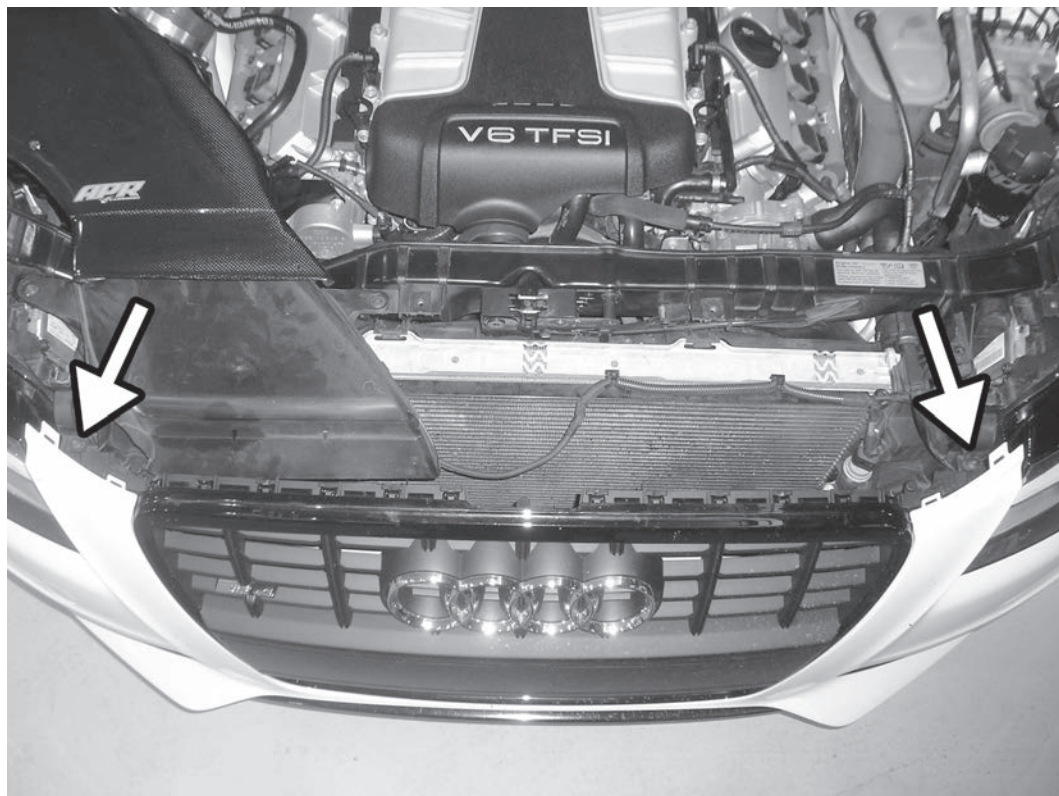

**TL100100**



16) Carefully pull the upper corner of both sides of the bumper away from the mounting brackets on the front fenders.

***APR***

17) With an assistant, carefully pull bumper cover forward and disconnect left and right fog light harness. Remove the HomeLink module from behind the center grille. Remove the bumper cover.

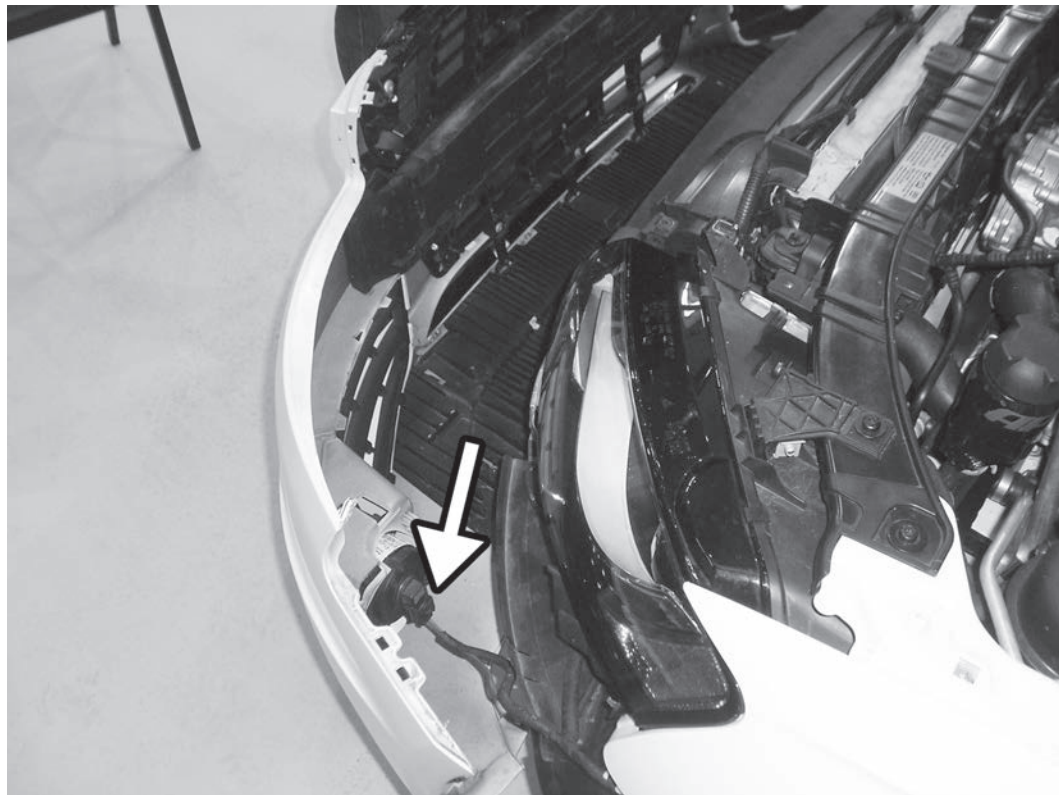



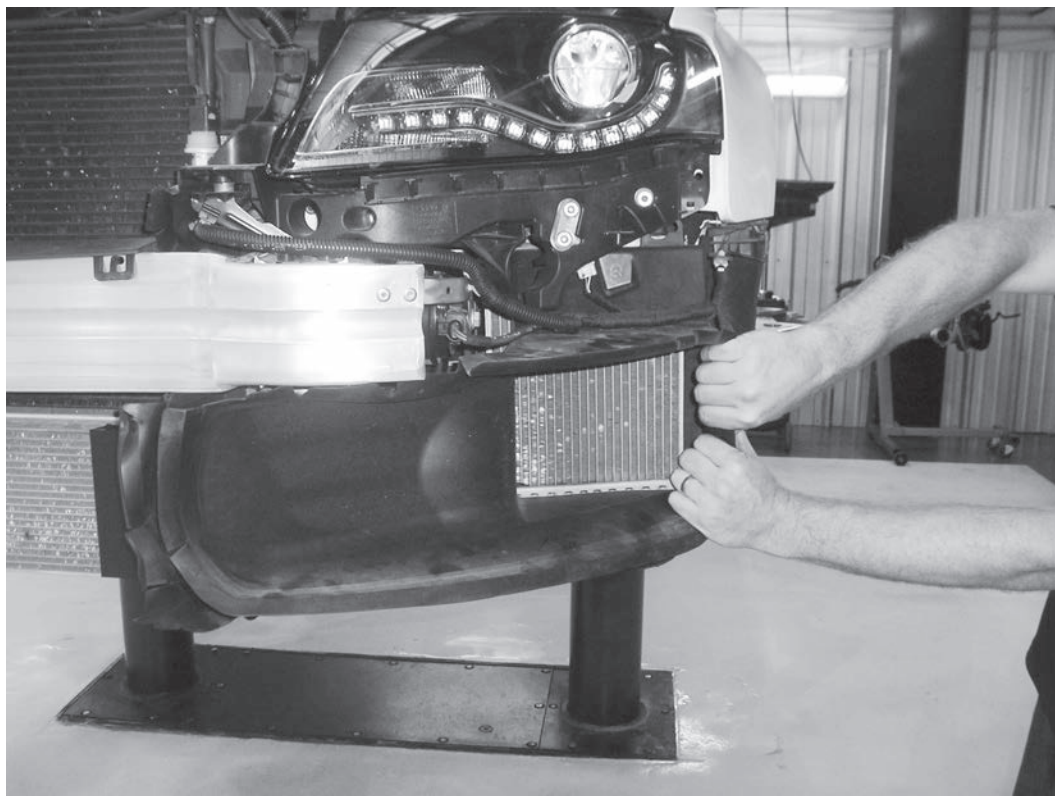

18) Carefully remove the radiator ducting, if equipped.

**APR**

19) Disconnect the lower hose from the supercharger's radiator and allow the coolant to drain out. On the B8, the lower hose is on the right side, on the B8.5 and all 4.0T's the lower hose is on the left side.

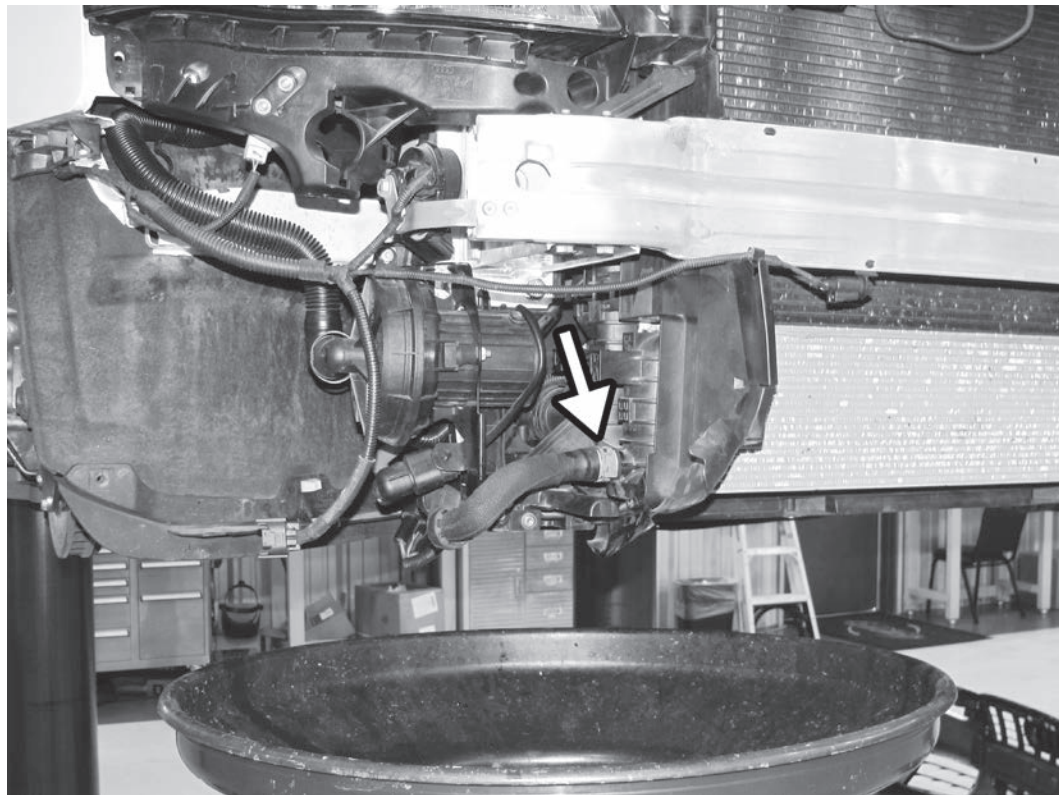

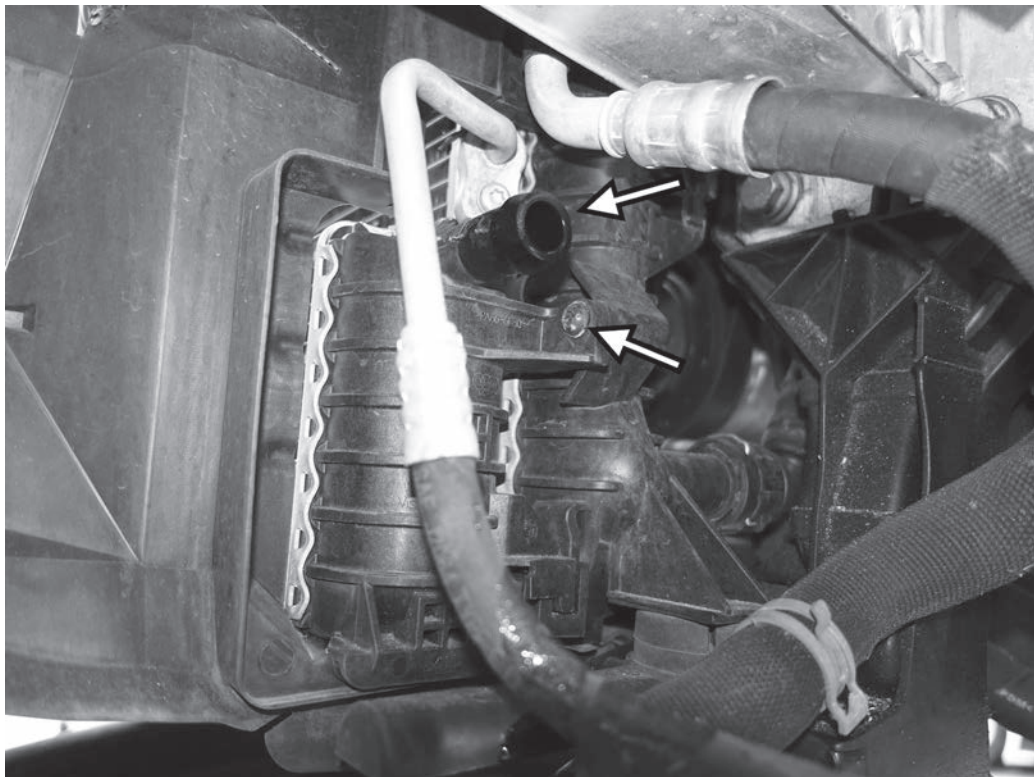

20) Once drained, disconnect the other supercharger radiator hose. On all vehicles, this is on the left side, just below the bumper beam. Remove the one T30 screw.



21) On the B8, follow the hose from the right side of the radiator back behind the core support, and disconnect the hose from the right hard line on the front of the engine.

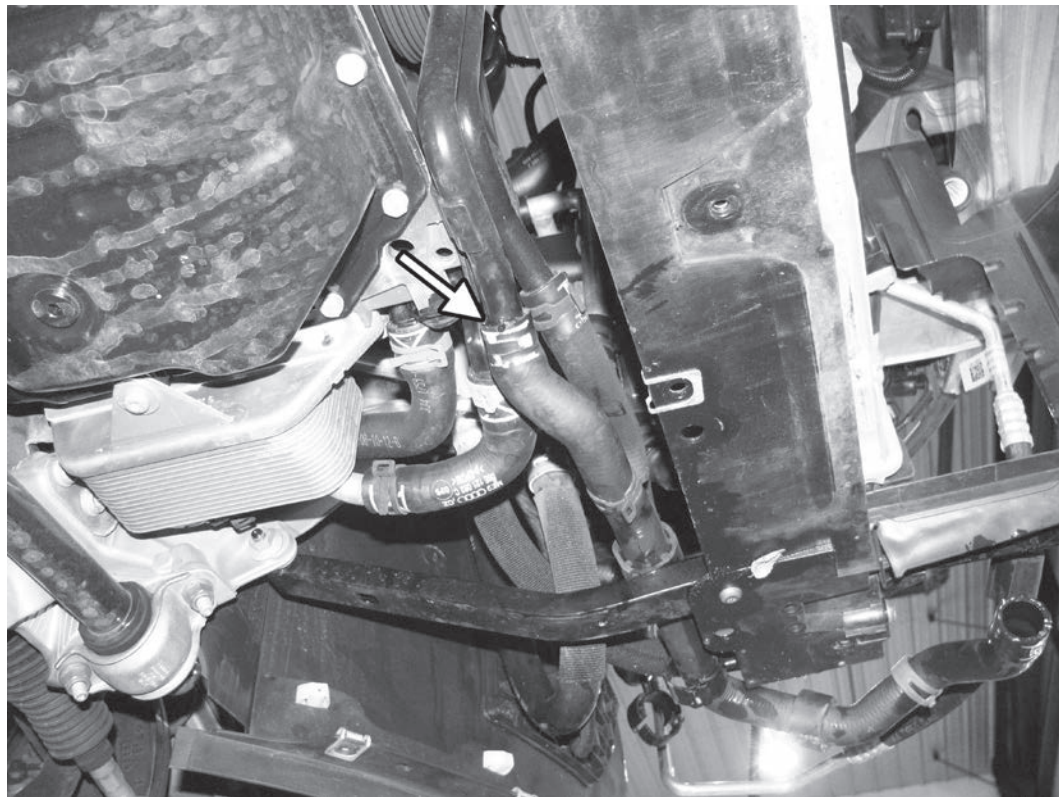

**TL100100**

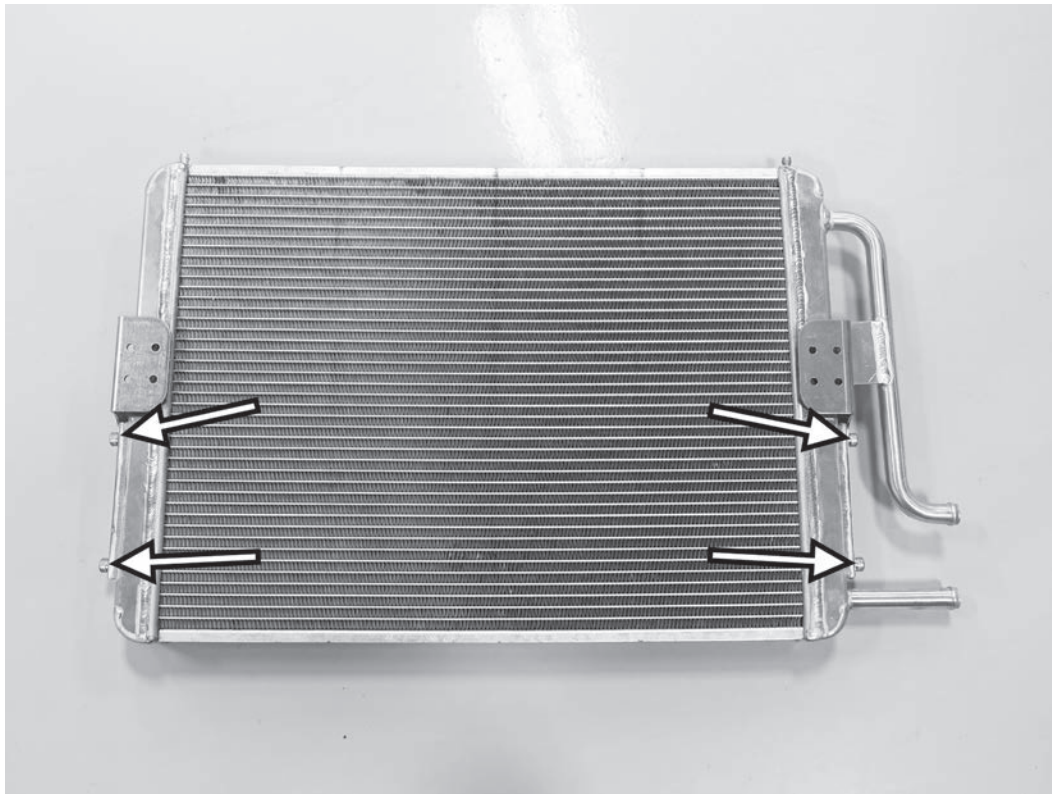

22) Temporarily bolt the radiator mounts to radiator with the four 5mm allen bolts.

23) Have an assistant hold the APR radiator in place and mark the location of the brackets on the bumper beam. Ensure the radiator is high enough to clear the engine's under tray and that the two tubes on the left side of the radiator have sufficient room to connect a hose. Remove the APR radiator from the car.

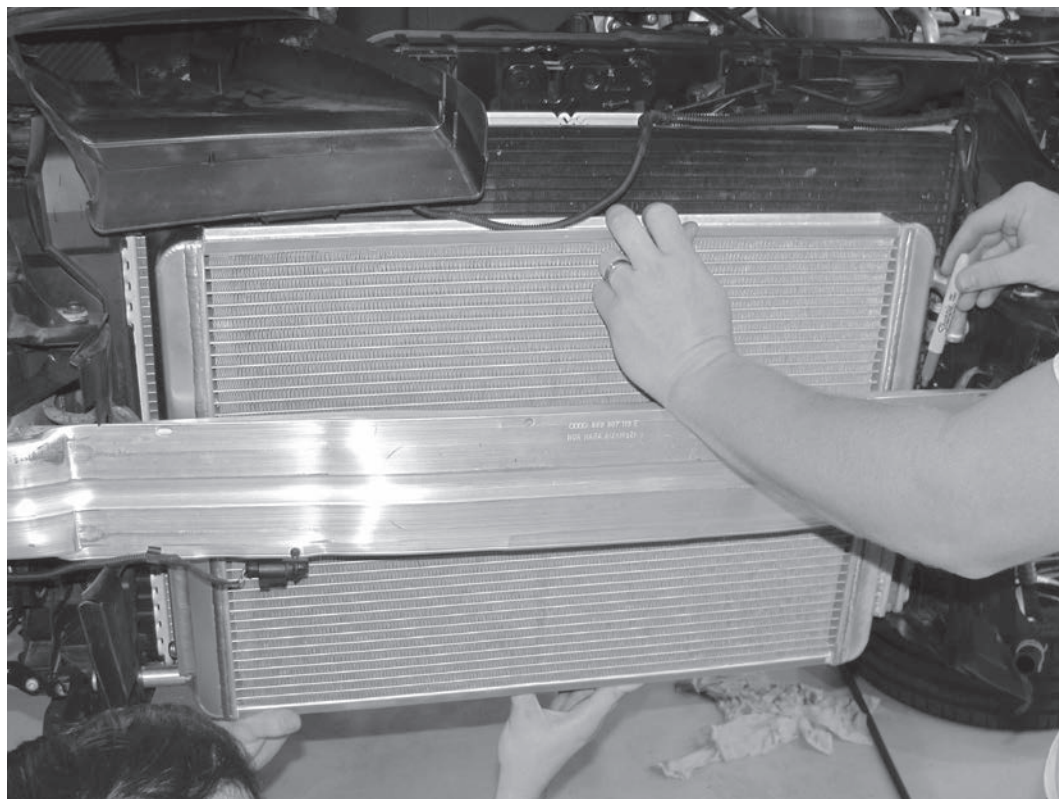

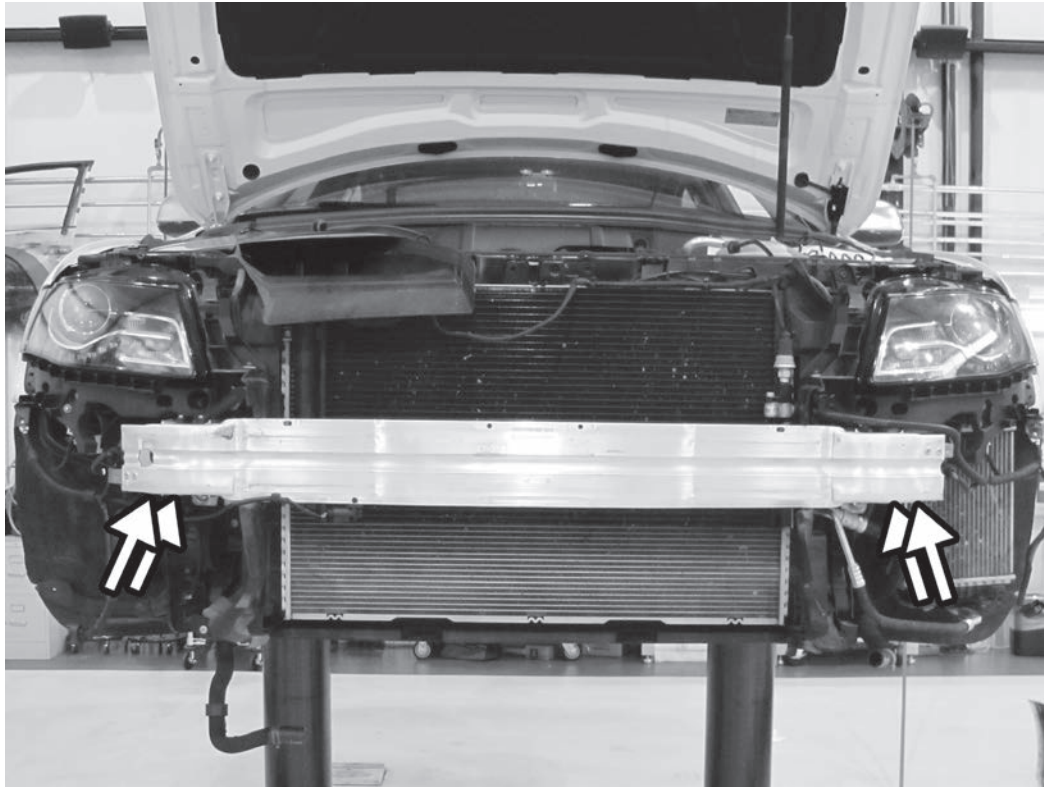

24) Unplug the horns and ambient air temperature sensor, unbolt the four 13mm bolts from the bumper beam, and remove bumper beam from the car. If equipped, disconnect and remove the headlight washer hose from inside the bumper beam.

25) Uninstall the two radiator brackets from APR radiator, and place in the location previously marked when bumper beam was on car. Mark the mounting holes in the brackets on the bumper.

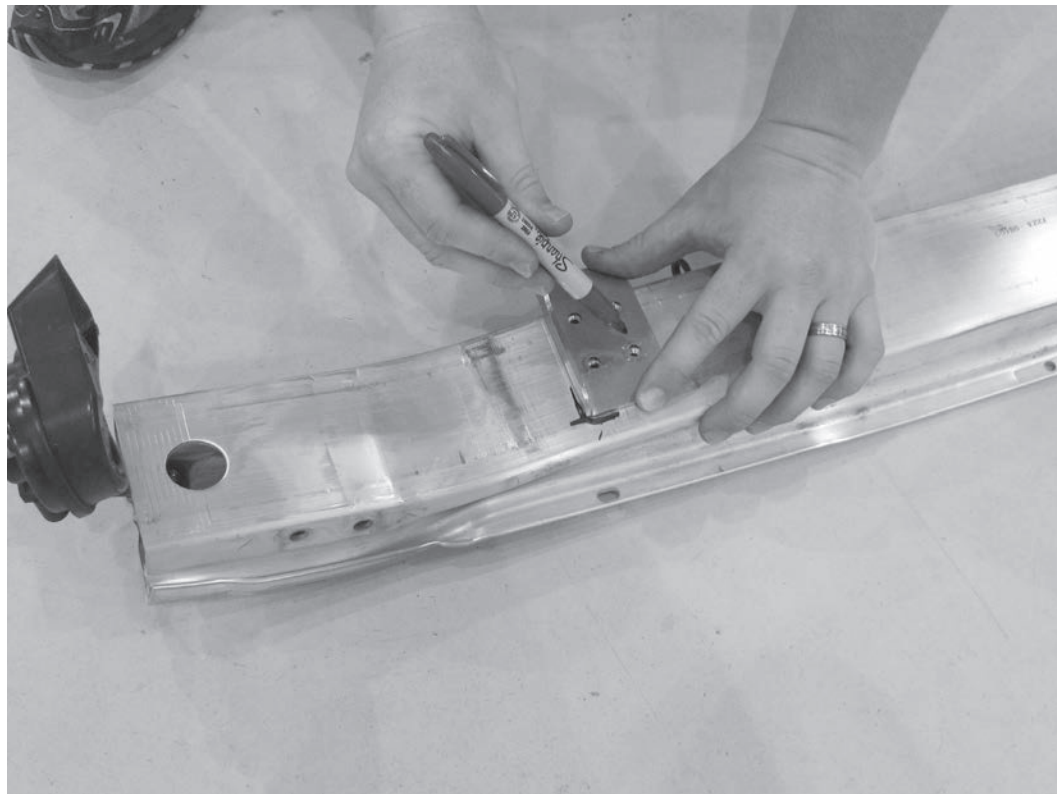



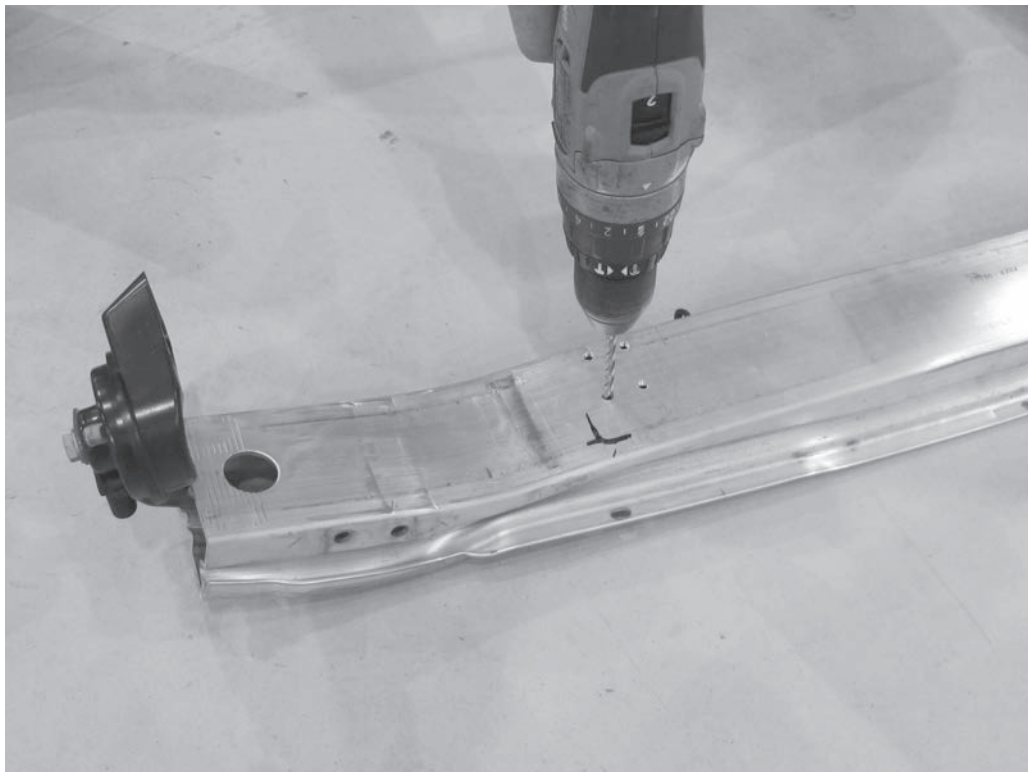

26) Drill the holes in the marked location with the supplied drill bit.

27) Attach the brackets to the bumper beam with the eight 10mm self-tapping screws. If equipped, reinstall the headlight washer hoses.

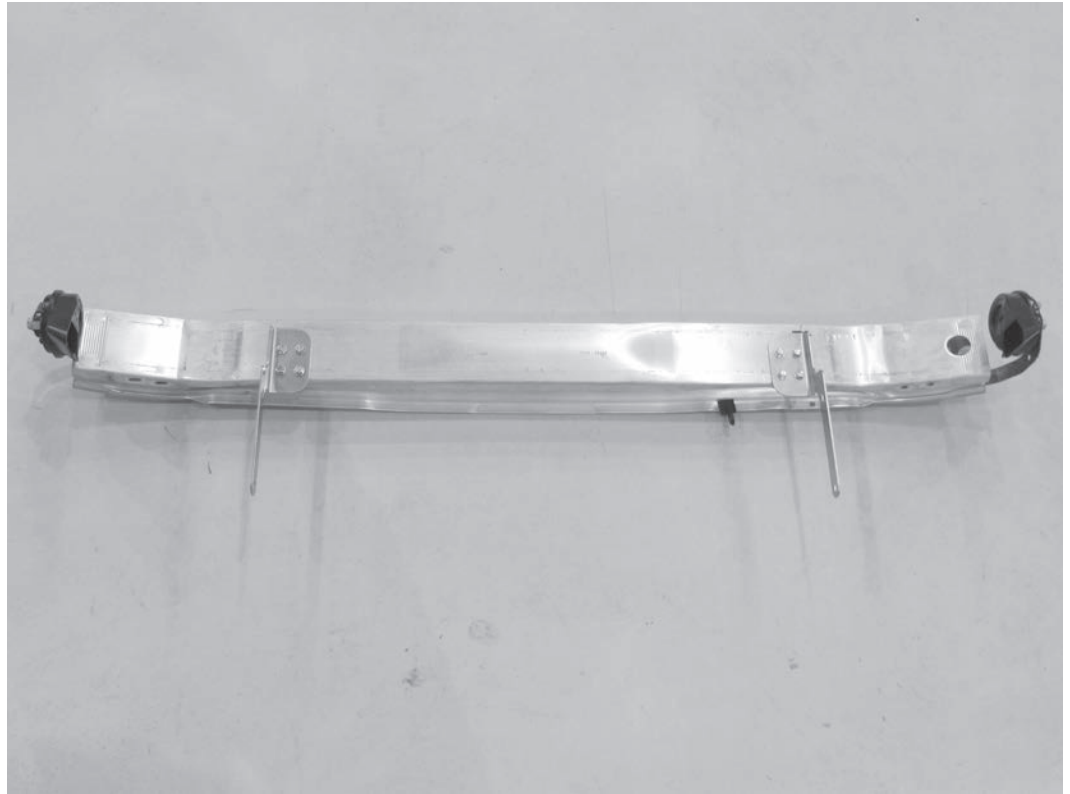

**TL100100**

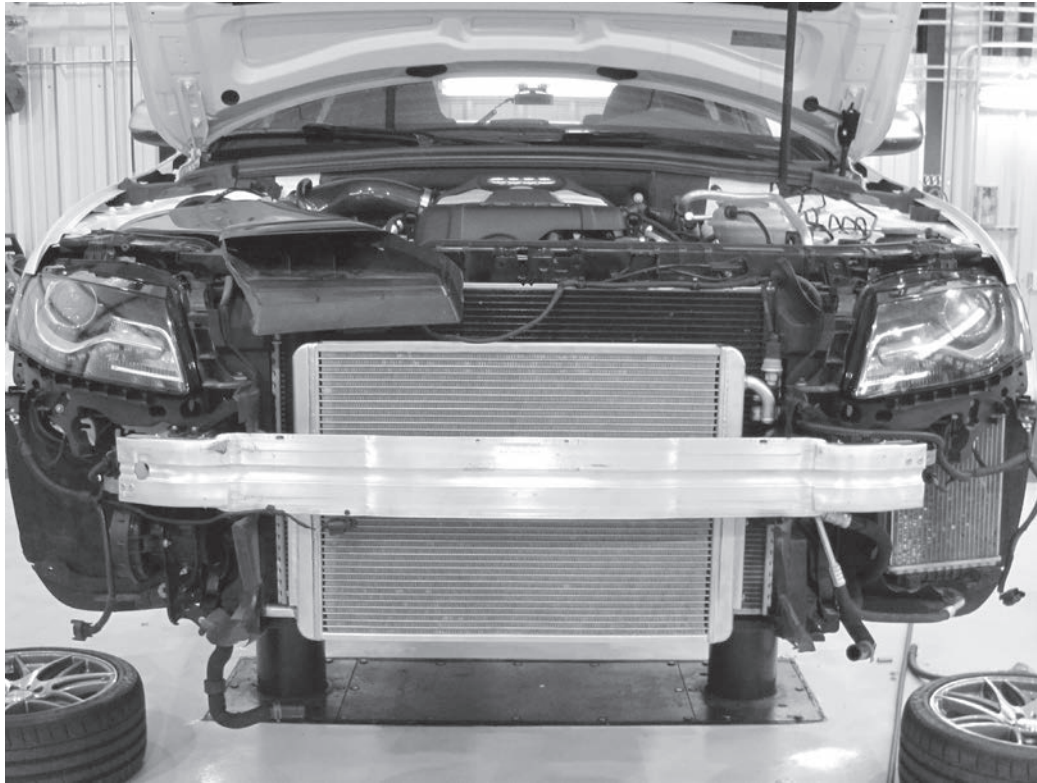

28) Attach the radiator to the bumper beam with the four factory 5mm allen bolts and lockwashers. Then, reinstall the bumper beam to the car. Be sure to reconnect the horns, the ambient air temperature sensor, and the headlight washer hose if equipped.



29) Connect the factory hose that went to the outlet of the factory radiator, to the top port of the APR cooler.

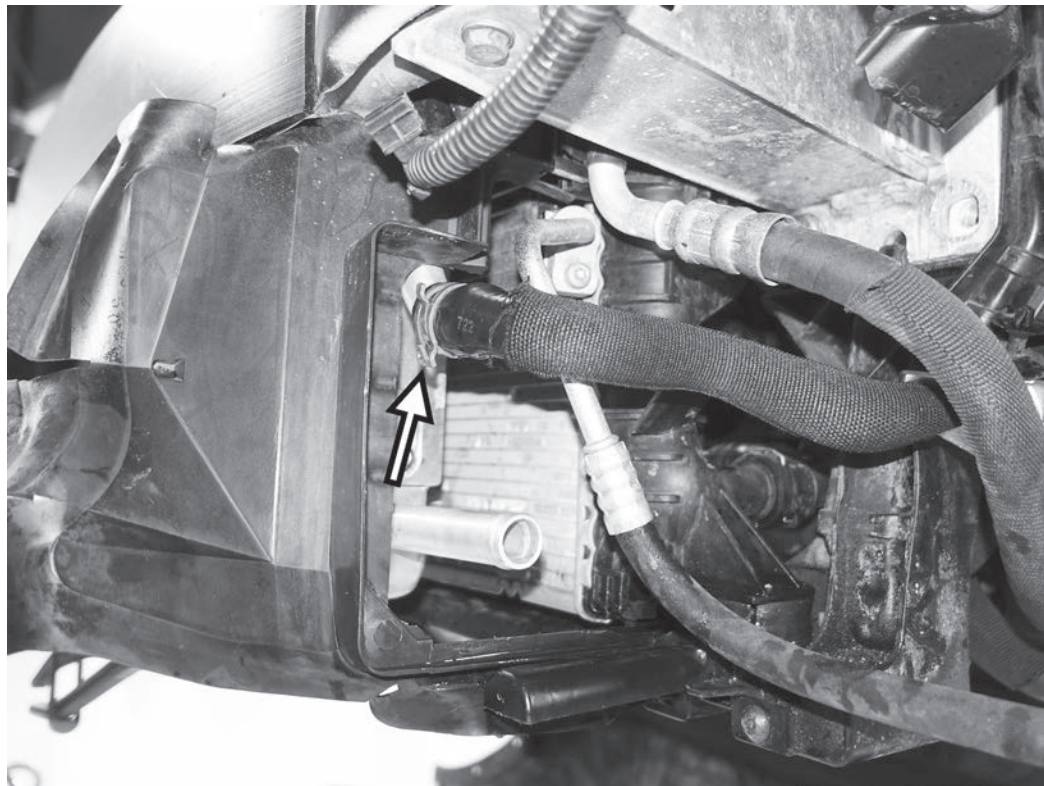

**TL100100**

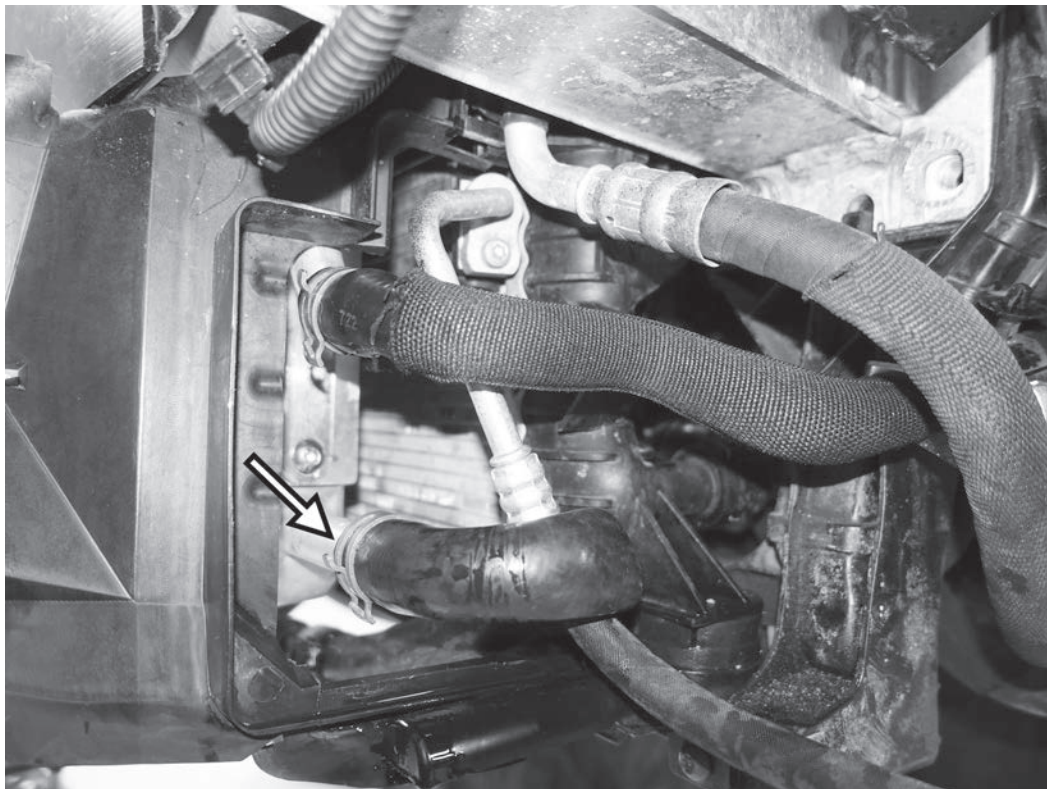

30) On a B8, connect the curved end of the supplied “J” shaped hose to the bottom inlet of the APR radiator, and secure with one of the larger spring style clamps. Route the hose behind the APR radiator and in front of the factory engine radiator.

On all other models, simply connect the lower factory hose to the bottom inlet port of the APR radiator.

**APR**

31) On the B8 only, connect the larger supplied hose to the end of the “J” shaped hose with the supplied reducing barbed coupler. Secure with one of the large spring clamps and one of the medium spring clamps.

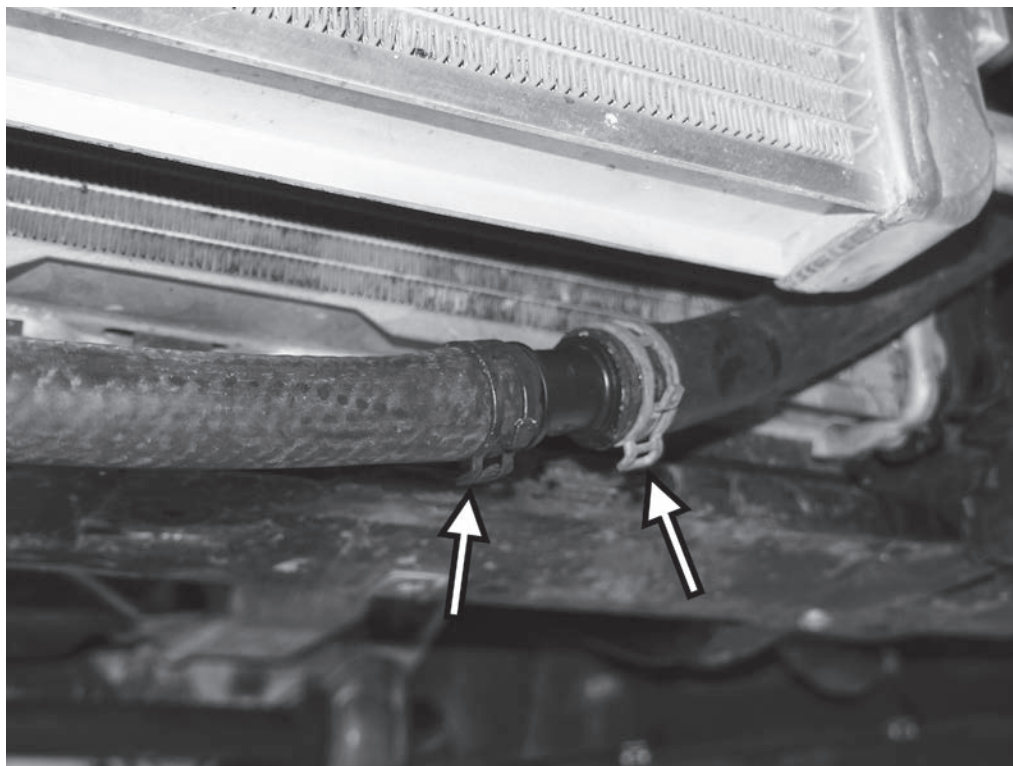

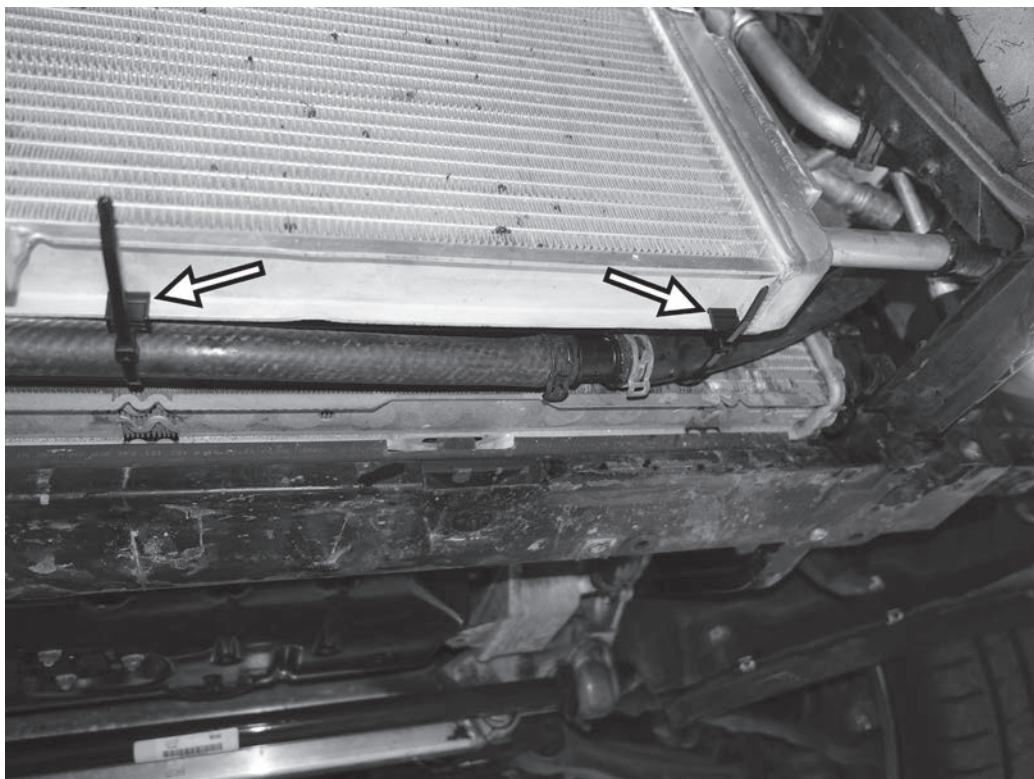

32) On the B8 only, secure the hose to the bottom lip of the APR radiator with the cable ties that have the push on retaining tabs.

**APR**



33) On the B8 only, route the lower hose around the right side of the radiator core support towards the back of the factory radiator, as shown.

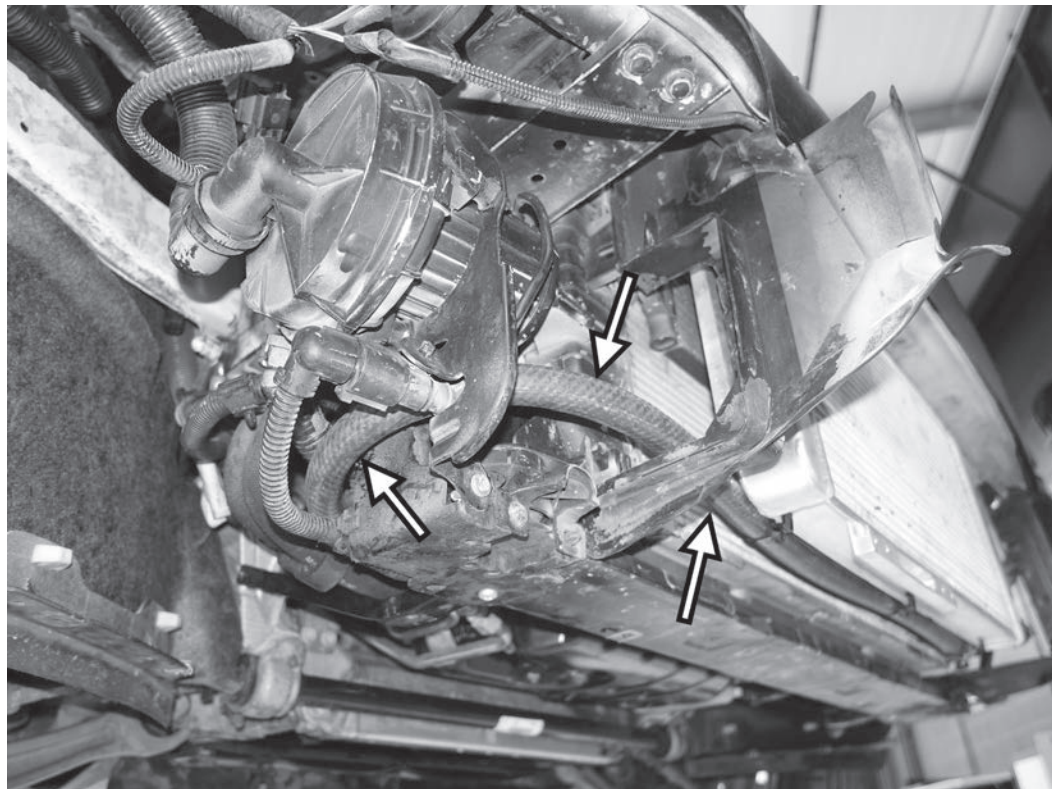

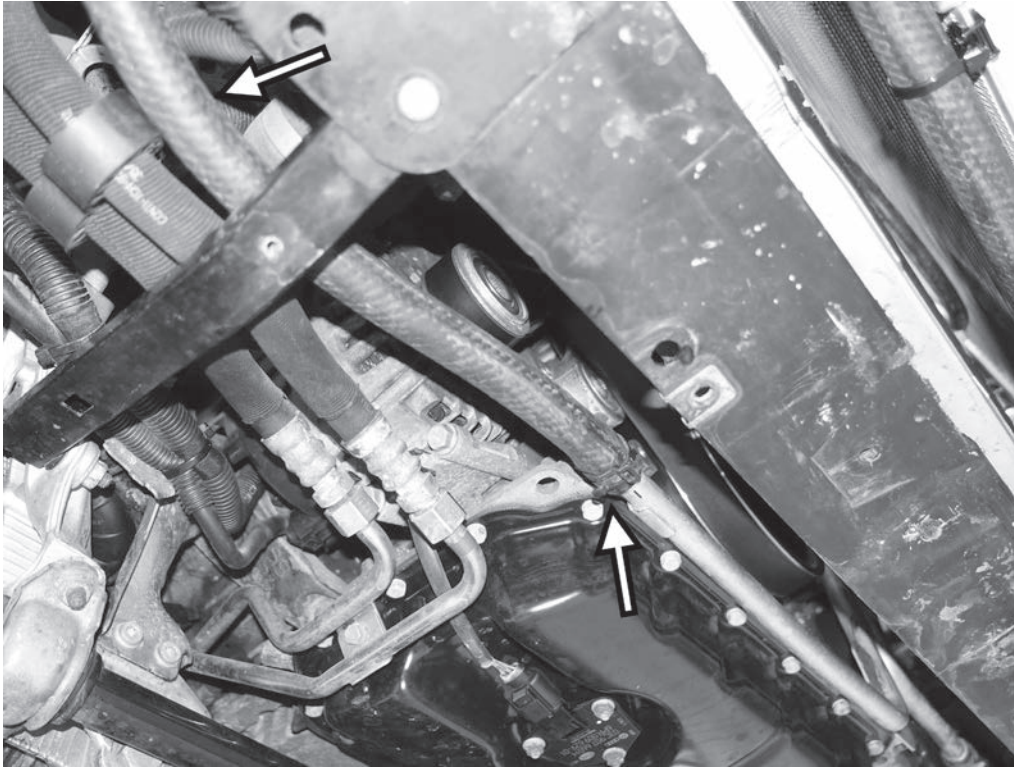

34) On the B8 only, connect the hose routed around the right side of the core support to the coolant pipe on the front of the engine, and secure with one of the medium spring hose clamps.



35) On both sides of the radiator, core support, remove the two pins holding the top of the engine radiator in place. Simply press the tab on the inside of the pin to the side, and then lift the pin away from the radiator.

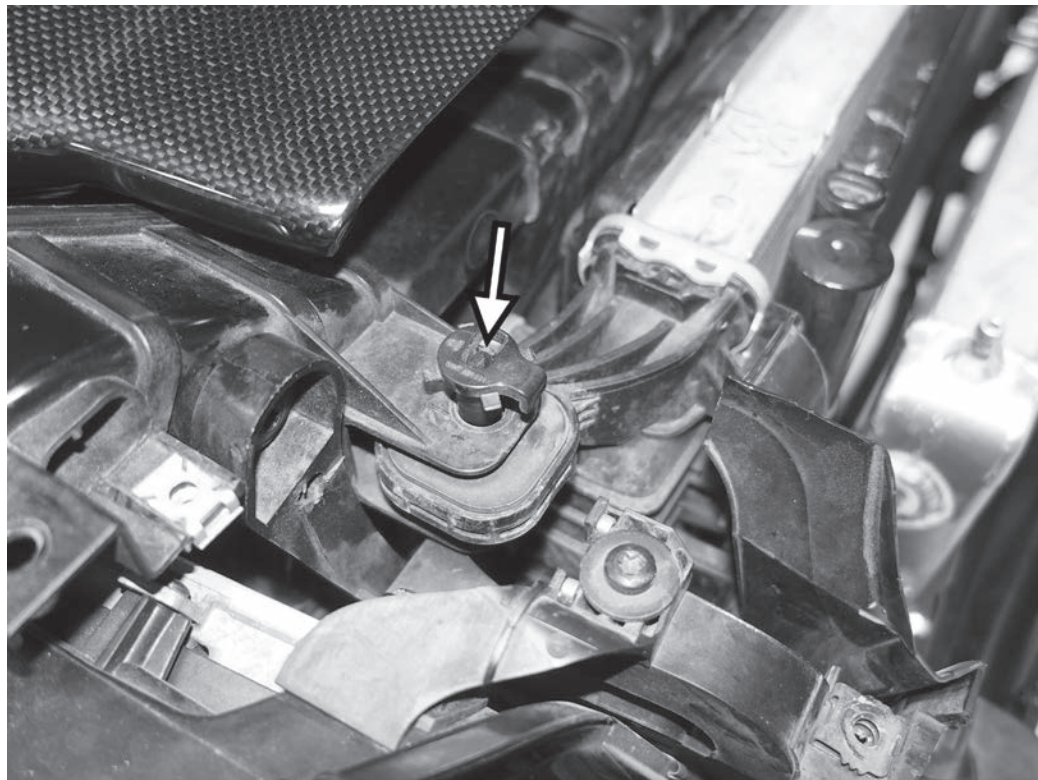

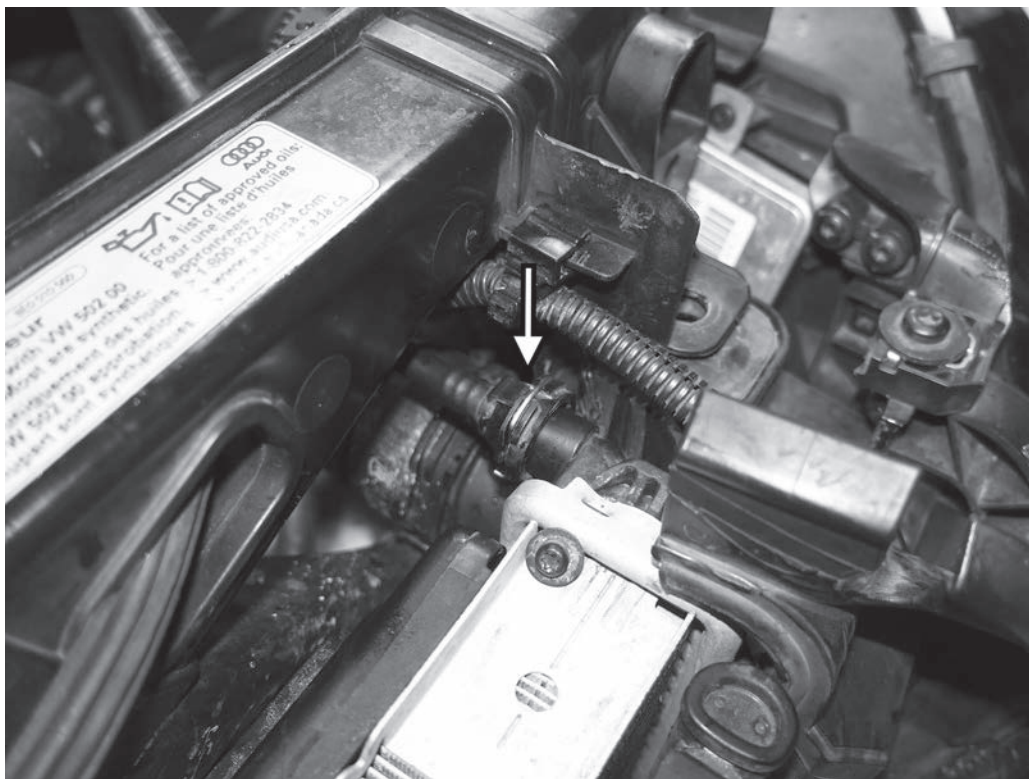

36) Carefully pull the top of the factory radiator forward. On the 3.0T's disconnect the coolant return line from the top left of the radiator by lifting up on the metal clip and then squeezing the line to disconnect. On the 4.0T's, this connection is located on the top right side of the radiator.

37) Lubricate the supplied O-ring with the supplied grease and install on the end of the APR coolant tap body. Install the jam nut on the coolant tap body and thread all the way on.

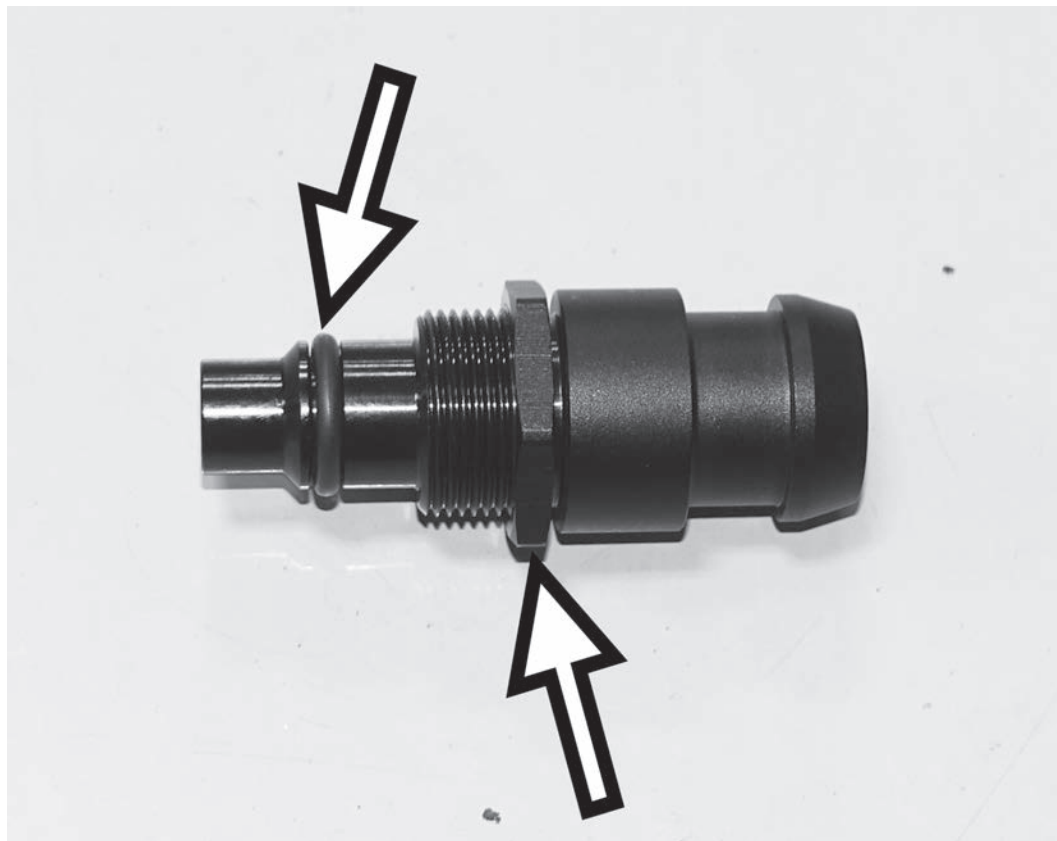

**TL100100**

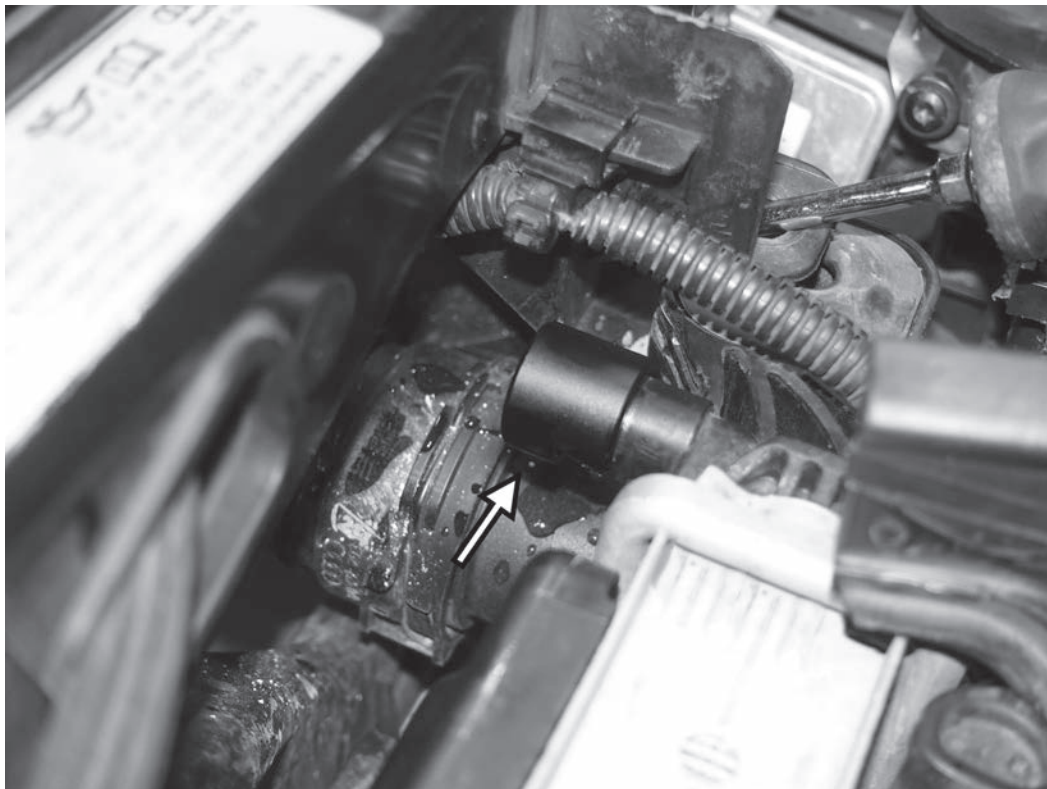

38) Install the coolant tap retainer onto the top of the coolant port on the top of the radiator. The half open side of the retainer should be facing down, with the threaded portion of the retainer facing the back of the car.

39) Thread the coolant tap body into the coolant tap retainer until tight. Once tight, back the coolant tap body off until the side port for the coolant tap fitting is facing towards the center of the vehicle and slightly up (3.0T on left side of radiator) or slightly down (4.0T on right side of radiator).

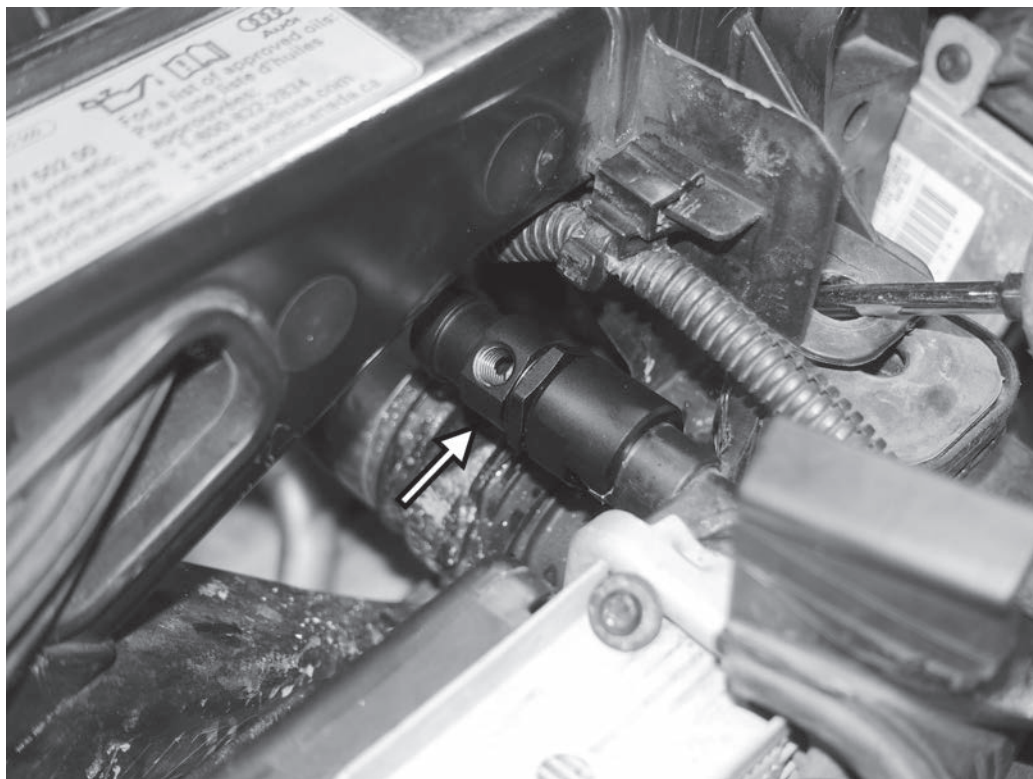



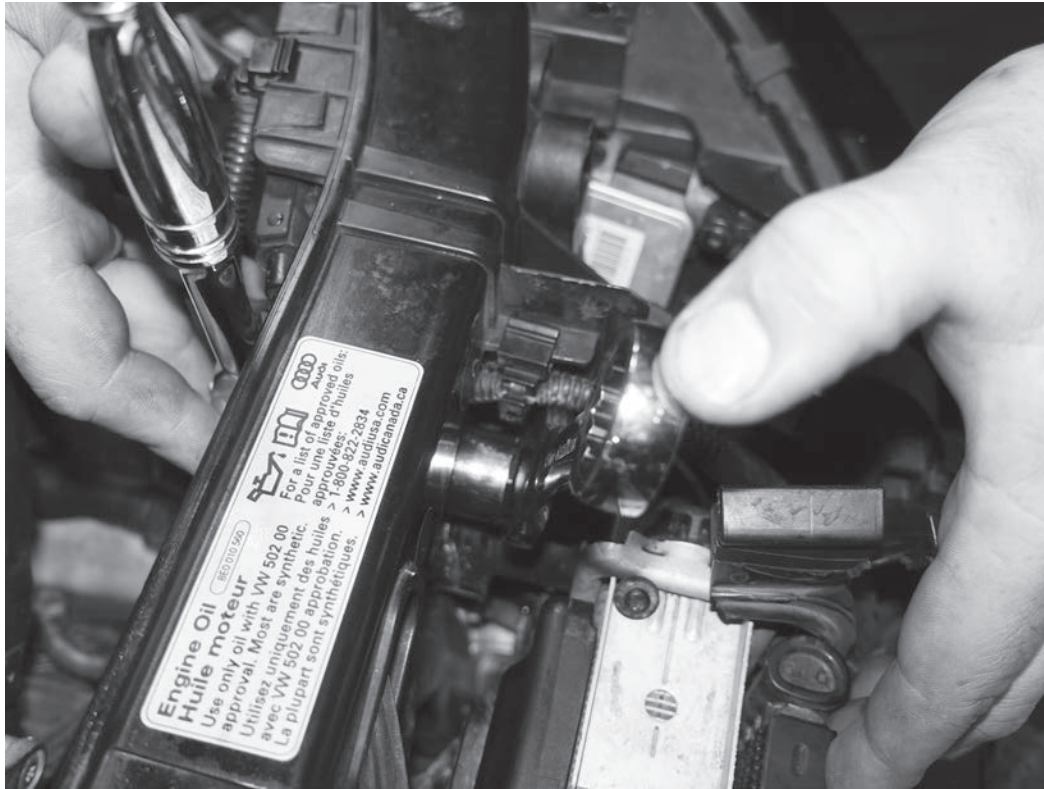

40) Using a 19mm open ended wrench on the coolant tap retainer, and a 19mm deep well socket on the coolant tap jam nut, tighten the jam nut onto the coolant tap retainer. In doing so, the coolant tap body will rotate slightly. Make sure the side port faces directly to the center of the vehicle once tightened.

41) Put a few drops of the supplied thread sealant on the threads of the brass coolant tap fitting and install it into the side of the coolant tap body, and tighten with a 10mm wrench.

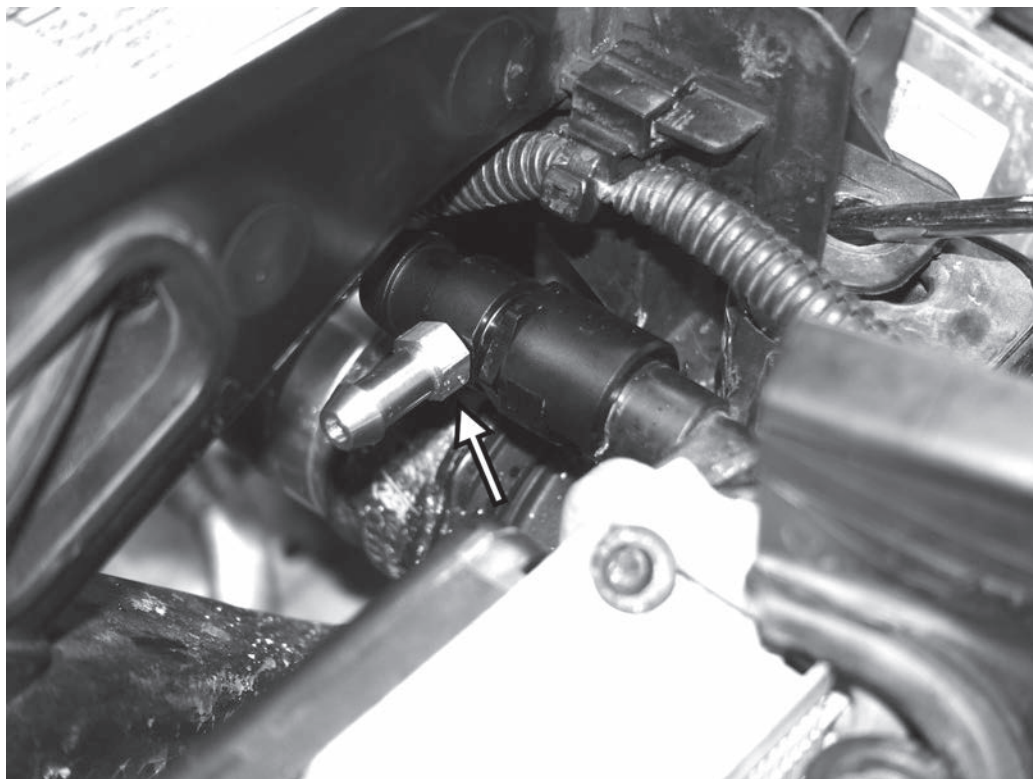

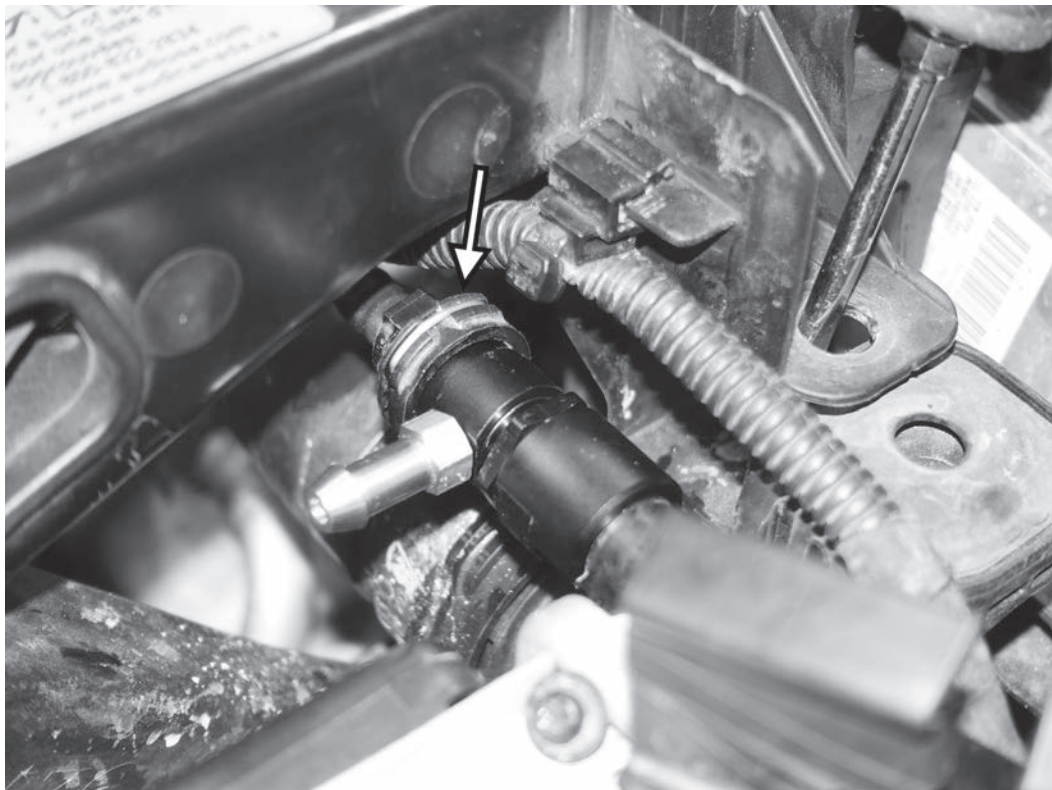

42) Reconnect the factory plastic coolant line to the back side of the APR coolant tap, making sure the clip on the fitting is locked in place.

**APR**

43) Build this assembly with the three way tee fitting, the six smallest spring clamps, and the smaller diameter supplied hose. Measure how much hose will be needed for the next step by loosely mocking this up on the car.

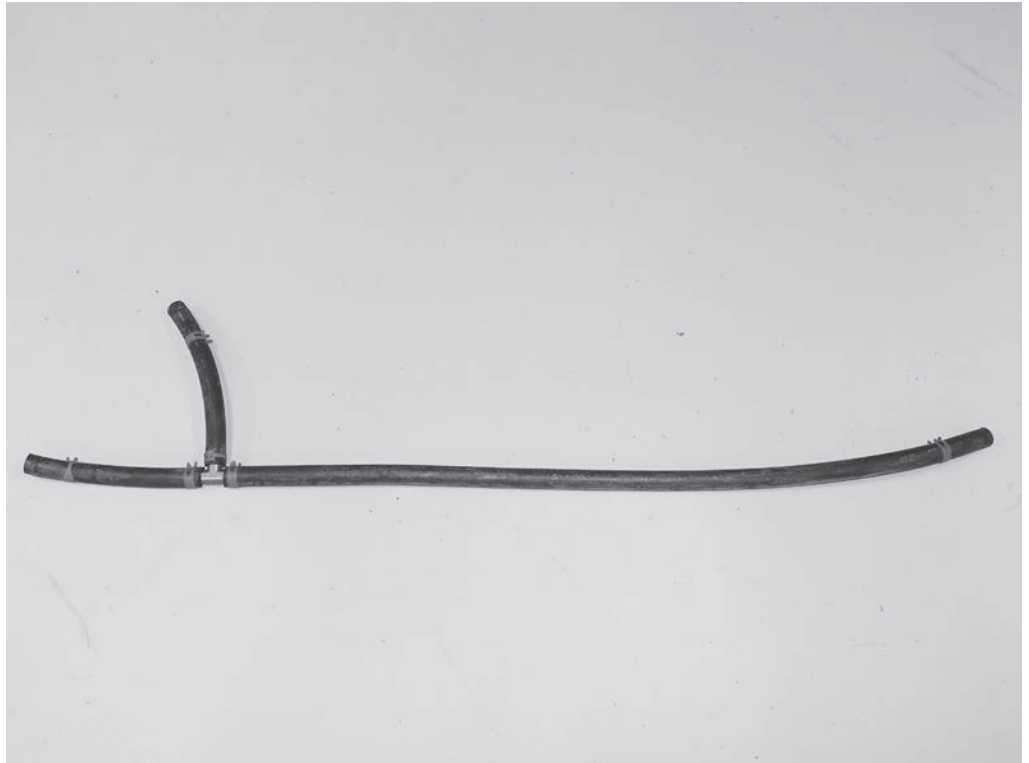

**TL100100**

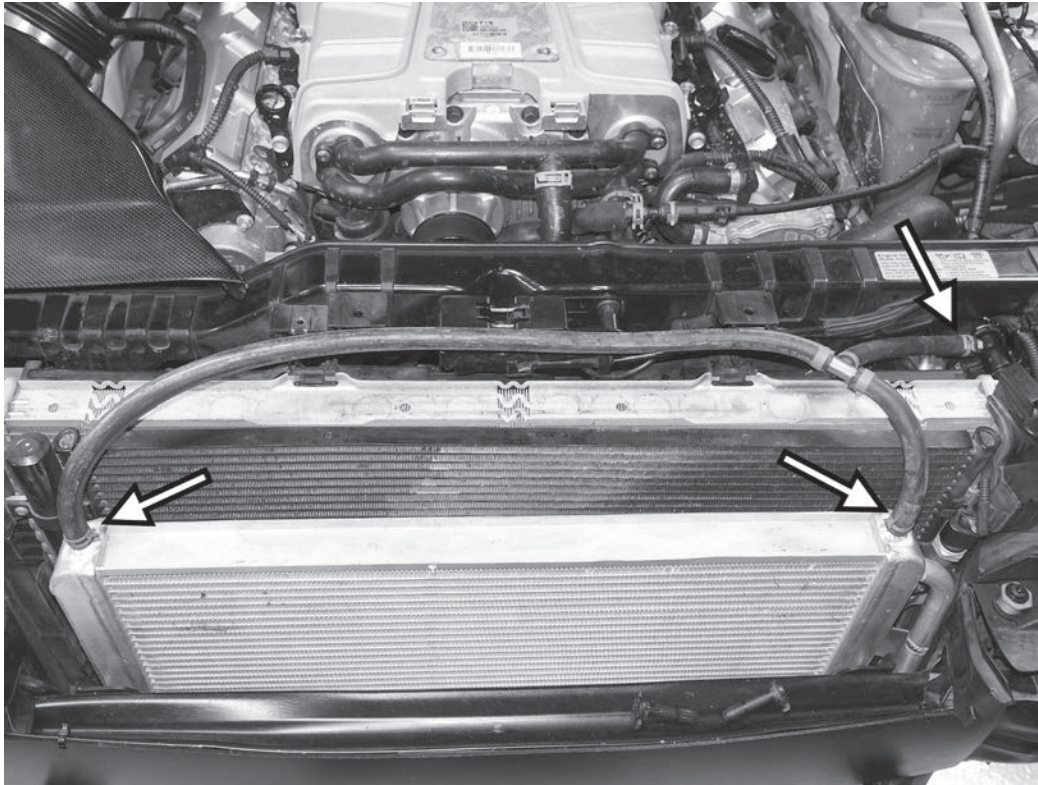

44) Connect the ends of the hose assembly to the barbs on both ends of the APR radiator, and secure with the supplied spring clamps. Connect the end off the tee fitting to the barb on the APR coolant tap and secure with a spring clamp.

***APR***



45) Secure the hoses to the top of the radiator with the supplied cable ties.

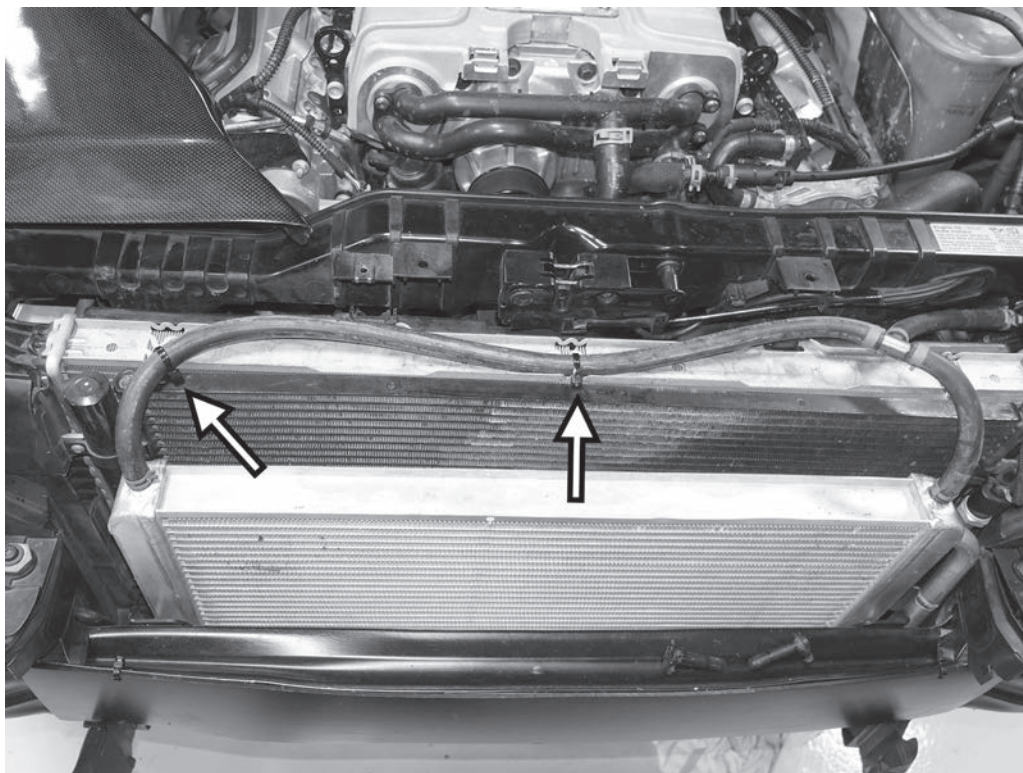

**TL100100**

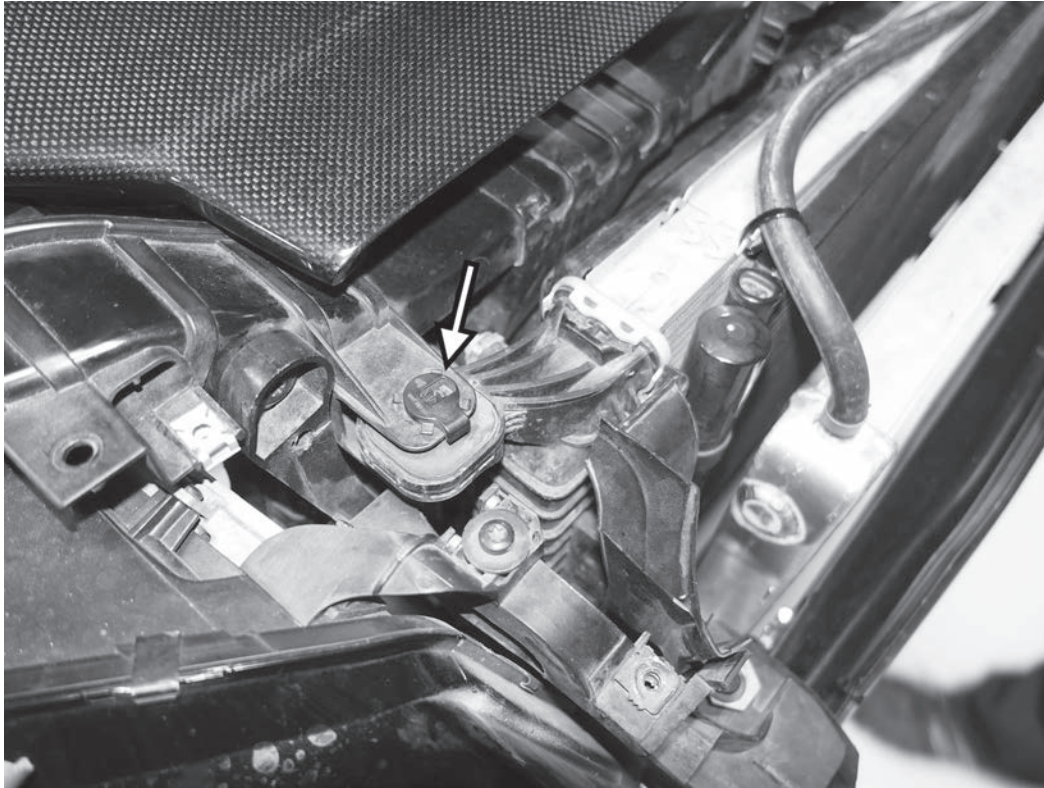

46) Push the top of the factory radiator back and install the two previously removed factory pins holding the top of the radiator to the core support.

47) If equipped, reinstall the air ducting for the side radiator.

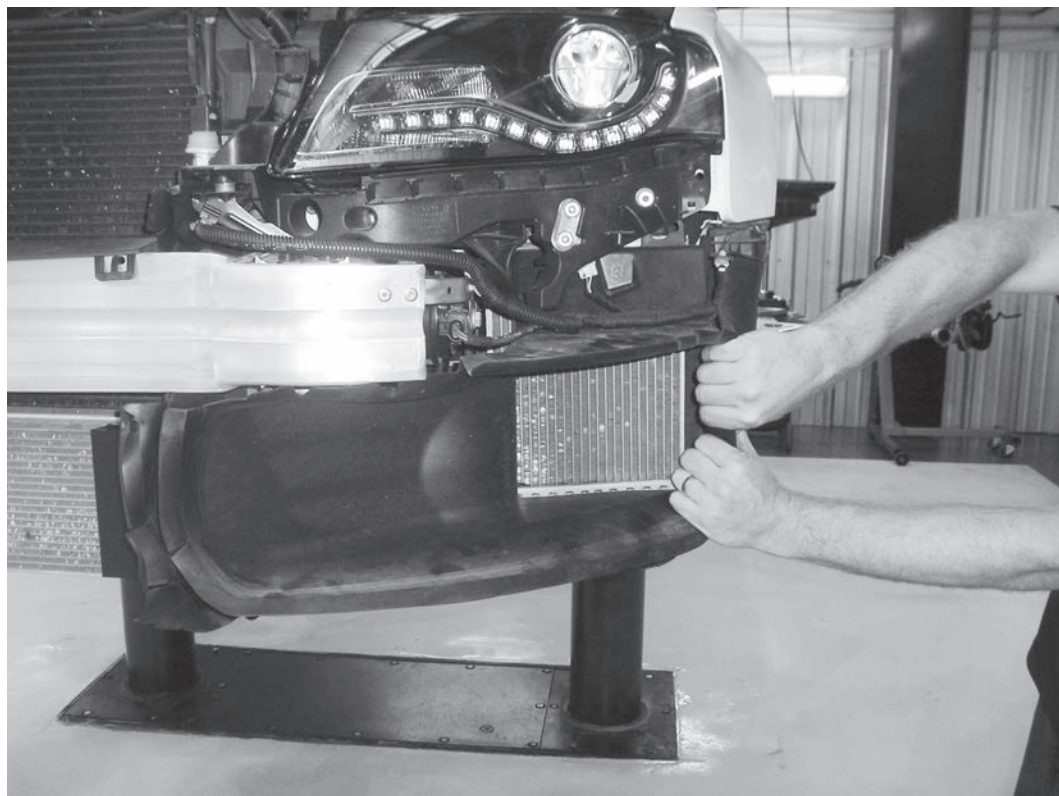

**TL100100**

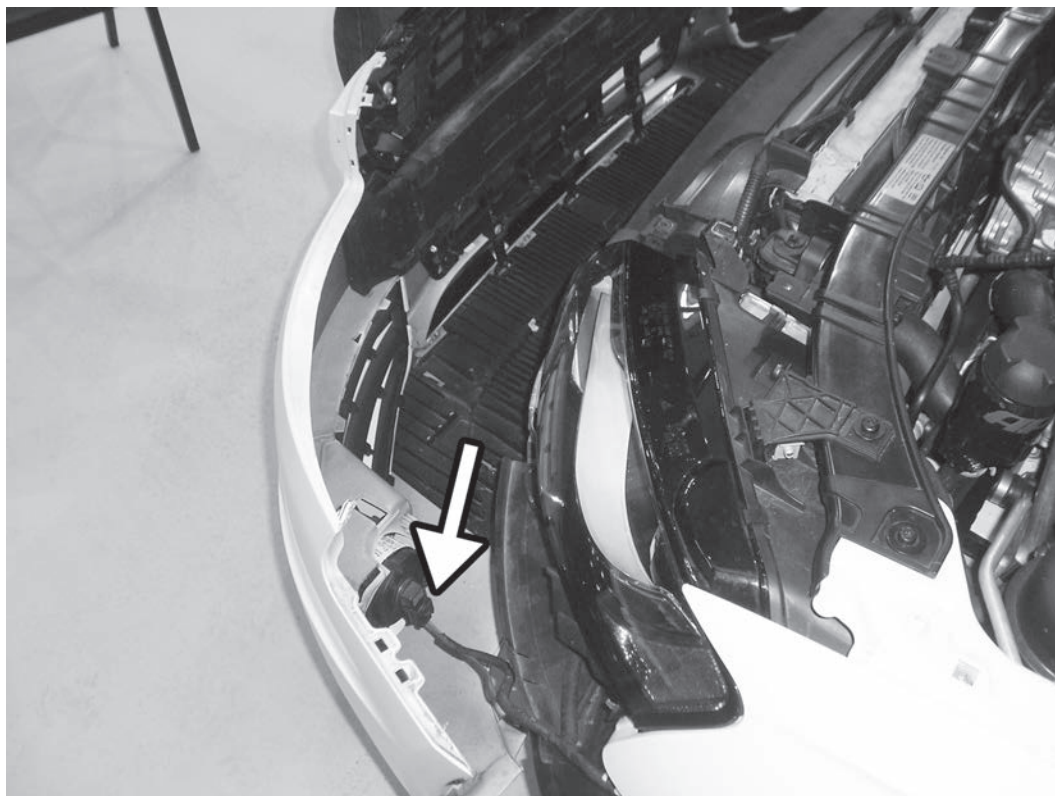

48) With an assistant, place the bumper cover near the front of the car. If equipped, reinstall the Home-Link module behind the center grille. Reconnect the left and right fog light harness. Set the bumper back to its original mounting location.



49) Carefully push both sides of the bumper cover back on the mounting brackets on the front fenders.



**TL100100**



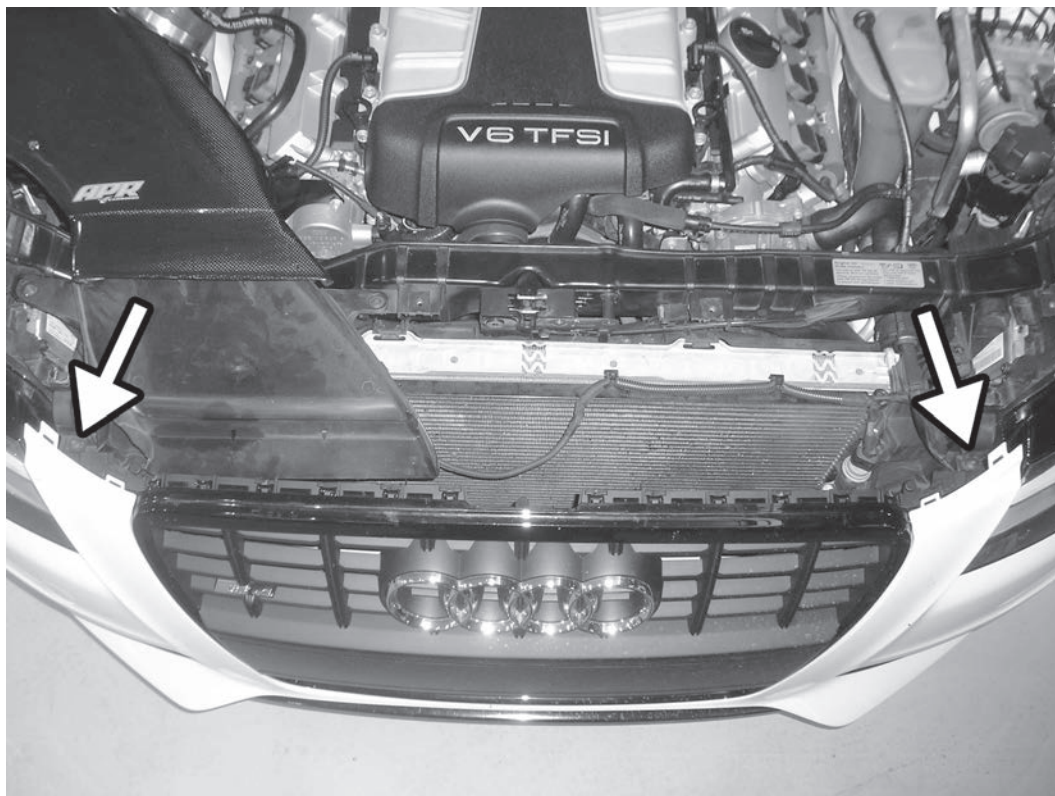

50) Reinstall the two T25 screws from the top of the bumper cover near the headlights.

**APR**

51) Reinstall the upper bumper cover trim by placing the front side in the slot on the back side of the bumper cover, and then securing the cover with either the four T30 torx screws or the four push pin style fasteners.

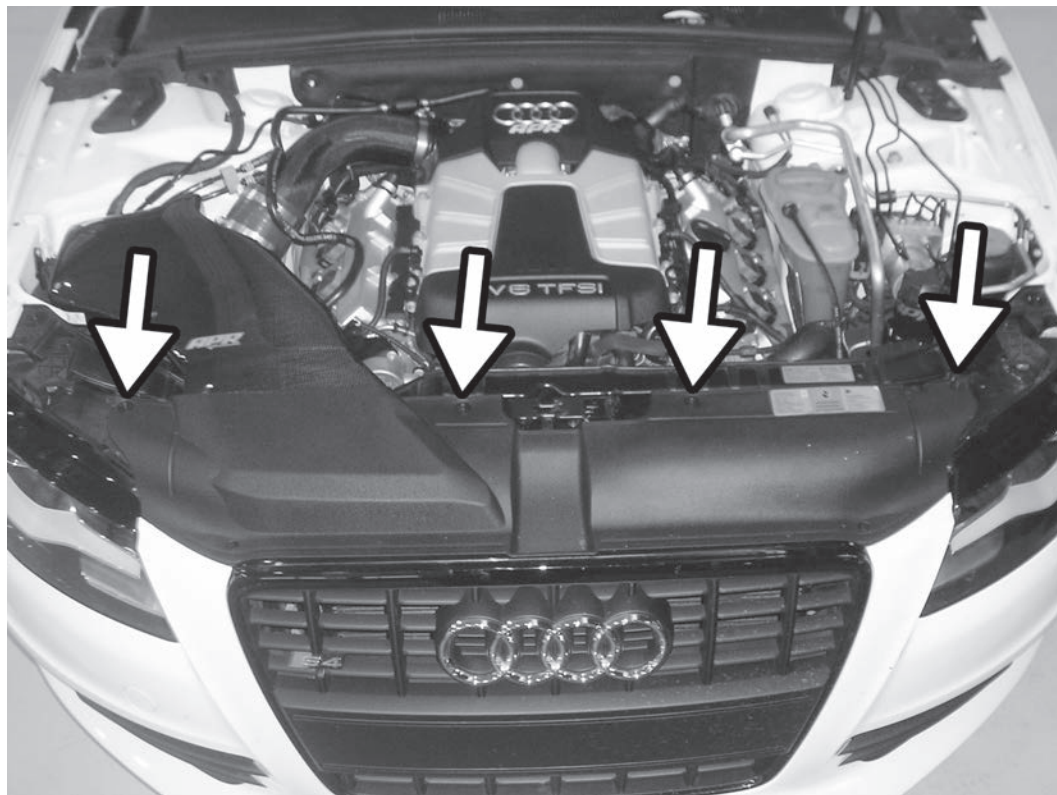

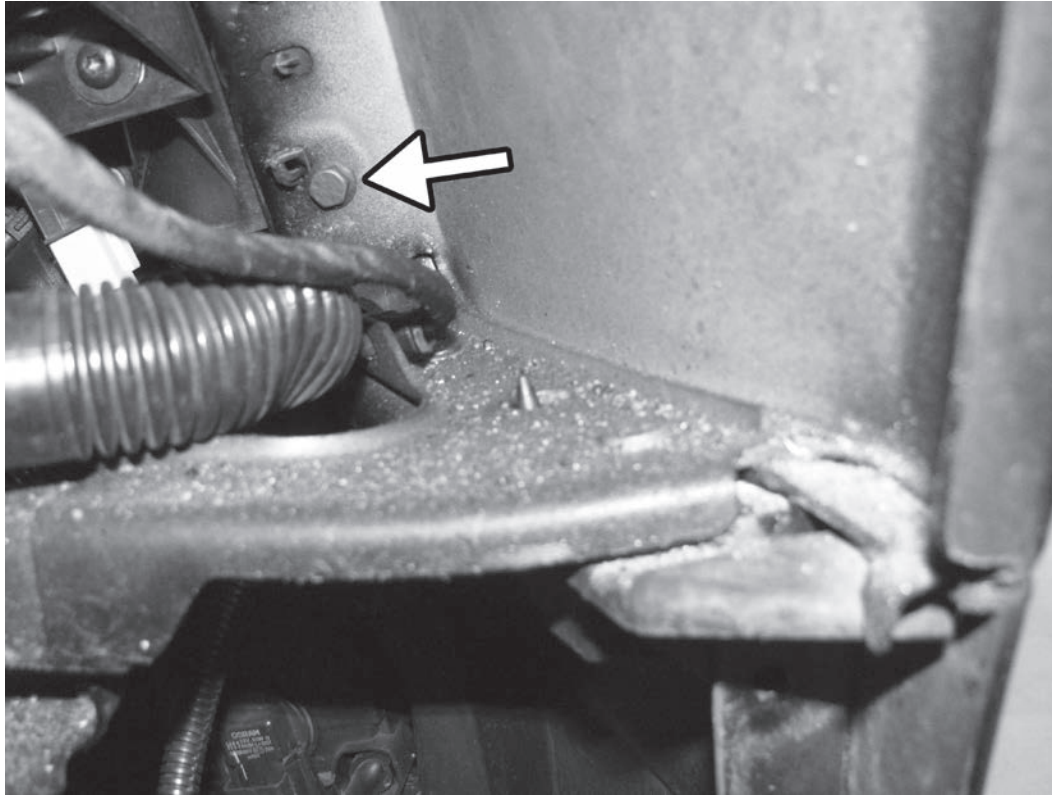

52) Pull back the fender liners on both sides and reinstall the two 10mm bolts that hold the front bumper cover to the front fender.

**APR**

53) Reinstall the belly pan on the car and secure the front side with the four T30 screws.

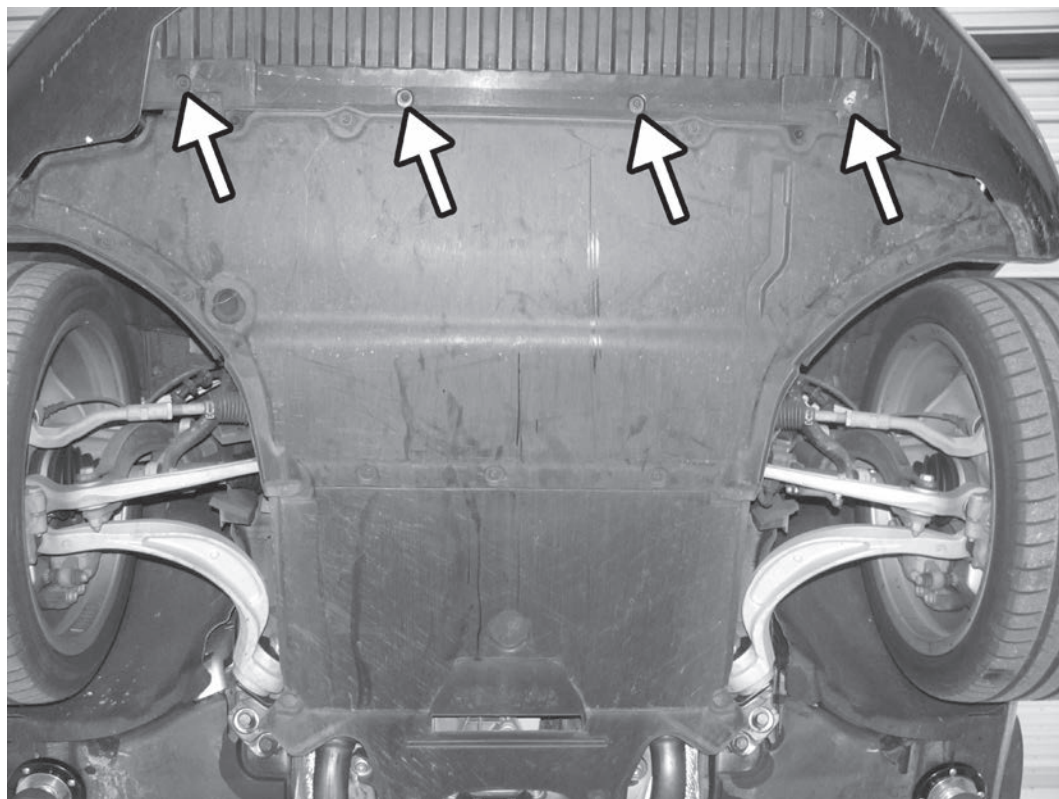



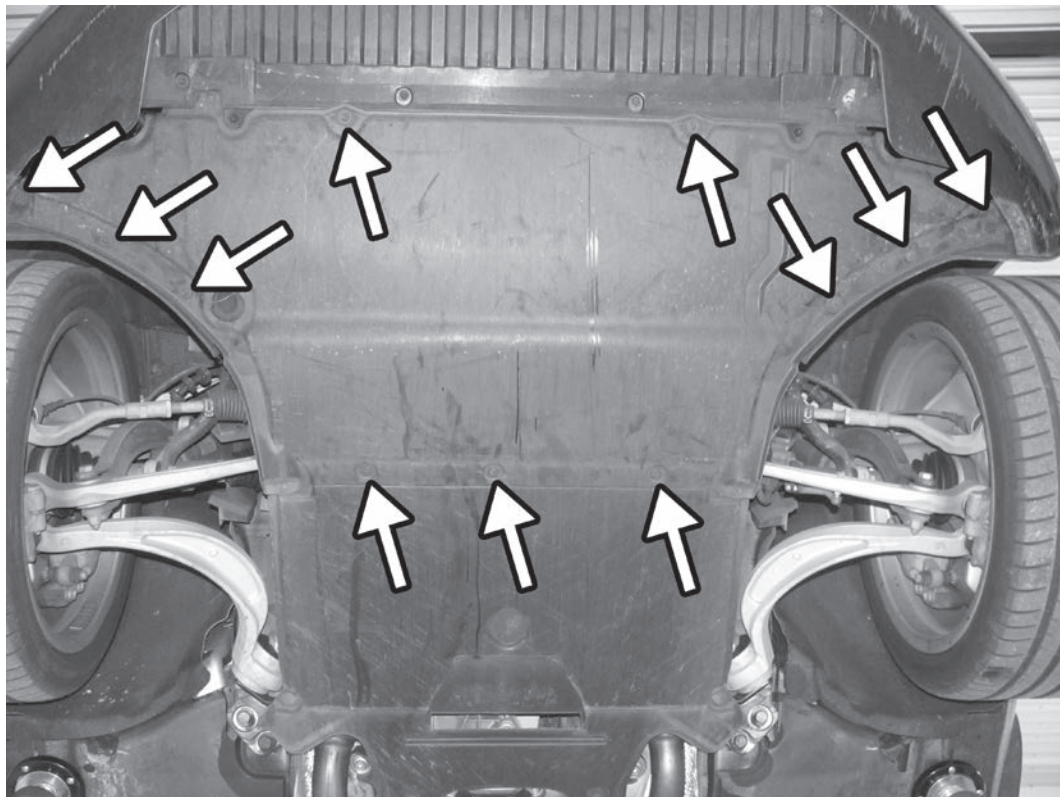

54) Reinstall the eleven quarter turn fasteners holding the belly pan in place.



55) On both sides of the car, reconnect the three T25 Torx screws and two push tabs that hold the front half of left front fender liner to the car. The B8.5 cars only have one push tab.

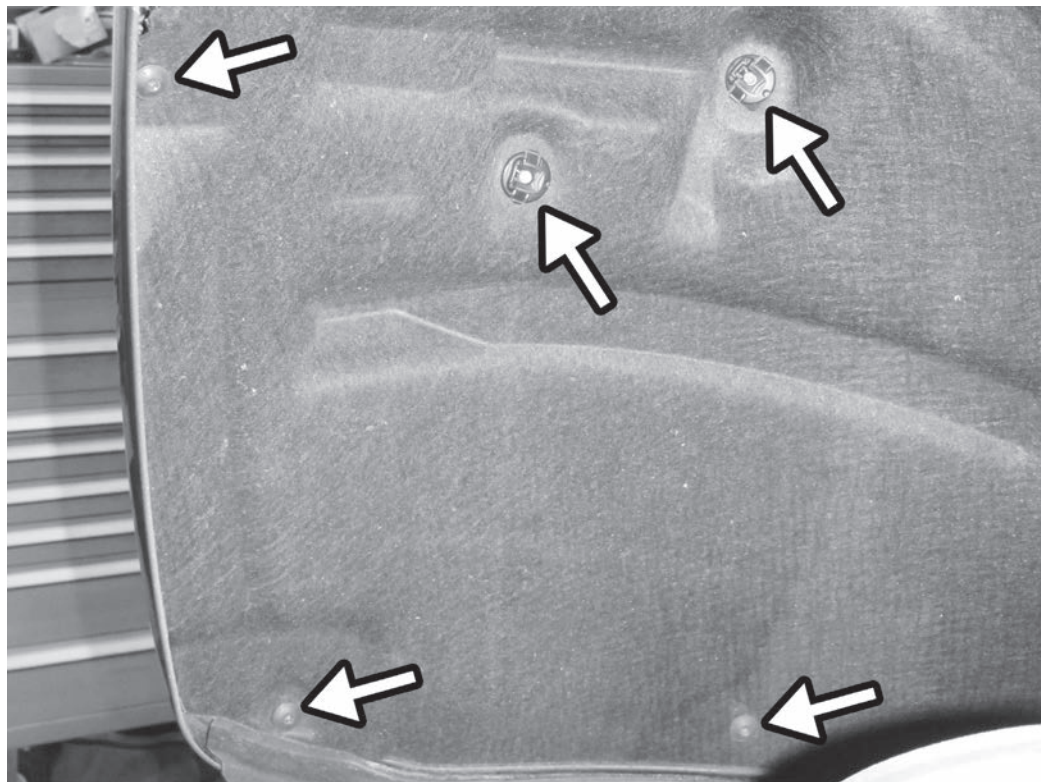

**TL100100**





#TL100100



INSTALLATION INSTRUCTIONS  
3.0T\4.0T COOLANT PERFORMANCE SYSTEM

